



Models



Model	Temp	RH	CO ₂	PIR	VOC
TUUB00-200 TUUB30-200 TUUB60-200	•				
TUUB00-201 TUUB30-201 TUUB60-201	•	•			
TUUB00-202 TUUB30-202 TUUB60-202	•	•	•		
TUUB00-203 TUUB30-203 TUUB60-203	•		•		
TUUB00-204 TUUB30-204 TUUB60-204	•			•	
TUUB00-205 TUUB30-205 TUUB60-205	•	•		•	
TUUB00-206 TUUB30-206 TUUB60-206	•	•	•		•
TUUB00-207 TUUB30-207 TUUB60-207	•	•	•	•	•



TUUB00 Series



TUUB30 Series



TUUB60 Series

Description

The TUUB is a universal wall-mount controller with a built-in temperature sensor and scheduler. The unit is designed for simple and accurate control of a heat pump, rooftop unit, fan coil unit or other heating/cooling equipment. Its field configurable algorithms enable versatile implementation of required control sequences.

The controller is available with additional sensors, such as the CO₂, VOC, PIR and humidity sensor, providing more functionality for the terminal device.

Equipped with an on-board humidity sensor, for accurate humidity control, this comprehensive unit also provides a dehumidification sequence compensated by auto activation of reheat output.

Features

- Heat pump, humidity control or general unit controller
- Fan control: 1, 2 or 3-speed (auto/on), or analog (ECM)
- Optional internal/external humidity sensor input for simple and accurate humidity control
- Dehumidification sequence compensated by auto activation of reheat output
- Real time clock (RTC) with 24-hour backup
- 7-day programmable schedule
- Precise temperature control with configurable PI (Proportional-Integral) function
- Selectable internal or external temperature sensor
- Low limit set protection (10°C / 50°F)
- Occupancy and night set back (NSB) mode
- Select direction on outputs
- Select controller's default display
- Multi-level lockable access menu and setpoint
- Selectable Fahrenheit or Celsius scale
- Option of pulse/floating/on-off output on binary outputs
- Internal/external occupancy input
- Compressor anti-cycling delay (configurable)
- ΔT control (on request)

Onboard Sensors

- Temperature sensor (°C/°F)
- Humidity sensor (%RH), select models
- Carbon dioxide sensor (CO₂), select models
- PIR motion detection sensor, select models
- Volatile organic compounds (VOC), select models

Network Communication

- BACnet® MS/TP or Modbus communication port (selectable via configuration menu)
- Select MAC address via menu or via network
- Automatic baud rate detection

BACnet MS/TP®

- Automatic device instance configuration
- Copy & broadcast configuration via menu or via BACnet to other controllers
- BACnet scheduler (up to 6 events per day)
- Firmware upgradeable via BACnet
- Supports COV (change of value)

Modbus

- Modbus @ 9600, 19200, 38400 or 57600 bps
- RTU Slave, 8 bits (configurable parity and stop bits)
- Connects to any Modbus master



Technical Specifications

Description	TUUB Series
Temperature Sensor	
Setpoint Range	10°C to 40°C [50°F to 104°F]
Control Accuracy	Temperature: ±0.4°C [0.8°F]
Display Resolution	±0.1°C [0.2°F]
Humidity Sensor (select models)	
Setpoint Range	10% to 90% RH
Control Accuracy	±3.5% RH
Display Resolution	0.1%
CO₂ Sensor (select models)	
Operating Principle	Self-calibrating, Non-Dispersive Infrared (NDIR)
Sensor Range	400 to 2000 ppm
Accuracy	±30 ppm ±3% of reading (Accuracy is defined after minimum 3 weeks of continuous operation)
Response Time	2 minutes by 90%
PIR Motion Sensor (select models)	
Operating Principle	Passive Infrared (PIR)
Detection Angle	100°
Detection Distance	4m [13ft]
Detection Area	
VOC Sensor (select models)	
Operating Principle	Self-calibrating, Non-Dispersive Infrared (NDIR)
Sensor Range	0-1000 ppb isobutylene equivalent tVOCs
Response Time	< 5 seconds for tVOC
Start up Time	15 minutes
Other	
Inputs	4 Universal Inputs (0-10Vdc, 10KΩ sensor, dry contact)
Outputs	6 Binary Outputs (OptoFET, 250mA max) 4 Analog Outputs (0-10Vdc, adjustable, 5mA max)
Power supply	22 to 26 Vac or Vdc 50/60Hz
Power consumption	1 VA max
Proportional band	0.5°C to 5°C [1°F to 9°F] adjustable (heat/cool/reheat independent)
Dead band	0.0°C to 5°C [0.0°F to 9°F] adjustable (heat/cool/reheat independent)
Electrical connection	0.8 mm ² [18 AWG] minimum
Operating temperature	0°C to 50°C [32°F to 122°F]
Storage temperature	-30°C to 50°C [-22°F to 122°F]
Relative Humidity	5 to 95% noncondensing
Degree of protection of housing	IP 30 (EN 60529)
Weight	135 g. [0.30 lb]
Dimensions: A = 4.88" 124mm B = 3.25" 83mm C = 1.75" 44mm D = 0.96" 24mm E = 2.07" 53mm F = 2.36" 60mm G = 3.28" 83mm H = 0.95" 24mm	



Wiring

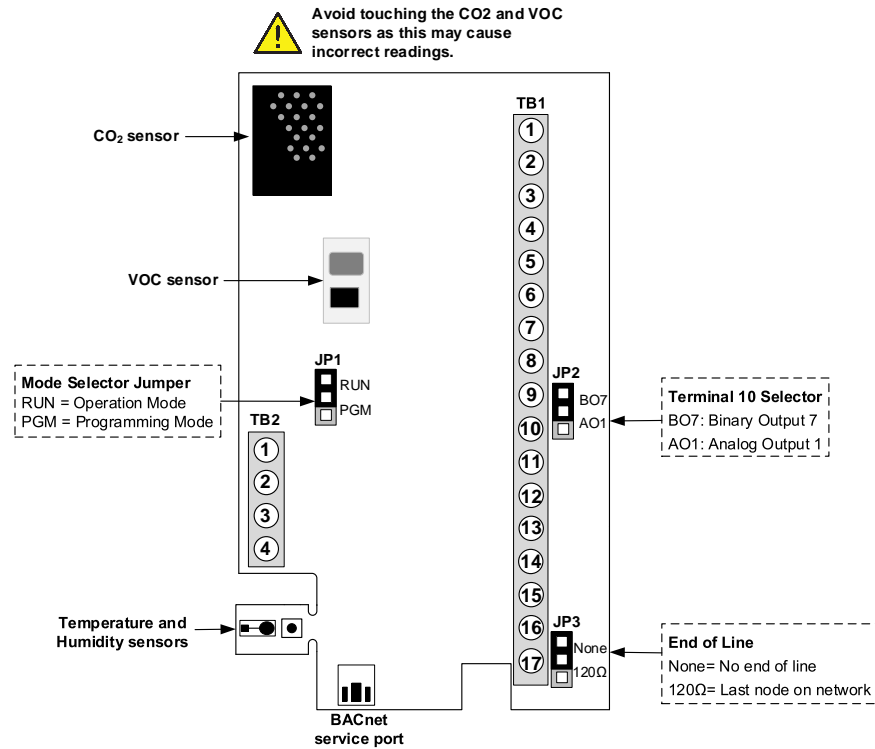

We strongly recommend that all Neptronic products be wired to a separate grounded transformer and that transformer shall service only Neptronic products. This precaution will prevent interference with, and/or possible damage to incompatible equipment.

Terminal Description

Terminals	Option Heat Pump			Analog Option				
	1-Speed Fan	2-Speed Fan	3-Speed Fan	Fan analog	1-Speed Fan	2-Speed Fan	3-Speed Fan	
TB1	1	Common			Common			
	2	24V (power supply)			24V (power supply)			
	3	External power supply			External power supply			
	4	Reversing Valve			select any ramp*			
	5	Compressor Y1			select any ramp*			
	6	Heat W1			select any ramp*			
	7	Compressor Y2	Compressor Y2	Fan (speed 3)	select any ramp*			Fan (speed 3)
	8	Heat W2	Fan (speed 2)	Fan (speed 2)	select any ramp*		Fan (speed 2)	Fan (speed 2)
	9	Fan (speed 1)	Fan (speed 1)	Fan (speed 1)	select any ramp*	Fan (speed 1)	Fan (speed 1)	Fan (speed 1)
	10	select any ramp*			select any ramp*			
	11	select any ramp*			Fan Speed option • Modulating 0-10Vdc for ECM Motors • Steps of 3,6,9V for 3 Speed		select any ramp*	
	12	select any ramp*			select any ramp*			
	13	Common			Common			
	14	Universal Input selection: • 0-10 Vdc (External sensor, humidity, CO ₂) • 10K Ohm (External sensor, changeover) • Dry Contact**			Universal Input selection: • 0-10 Vdc (External sensor, humidity, CO ₂) • 10K Ohm (External sensor, changeover) • Dry Contact**			
	15							
	16	BACnet communication port (A+)			BACnet communication port (A+)			
	17	BACnet communication port (B-)			BACnet communication port (B-)			
TB2	1	select any ramp*			select any ramp*			
	2	Common			Common			
	3	Universal Input selection: • 0-10 Vdc (External sensor, humidity, CO ₂) • 10K Ohm (External sensor, changeover) • Dry Contact**			Universal Input selection: • 0-10 Vdc (External sensor, humidity, CO ₂) • 10K Ohm (External sensor, changeover) • Dry Contact**			
	4							

* = select from any of the following ramps:

- Cooling 1 w/ fan
- Cooling 2 w/ fan
- Heating 1 w/ fan
- Heating 2 w/ fan
- Heating 2 without fan
- Cool/Heat 1 w/ fan
- COR (changeover) w/ fan
- Humidity w/ fan
- CO₂ Alarm
- Off

** = select from any of the following:

- Off
- Override
- Flow Switch
- Local/Remote Selector Switch
- Overheat
- Dirty Filter
- Window & Door Contacts
- Occupancy & NSB Sensor
- Changeover Input



Power Supply for Binary Outputs

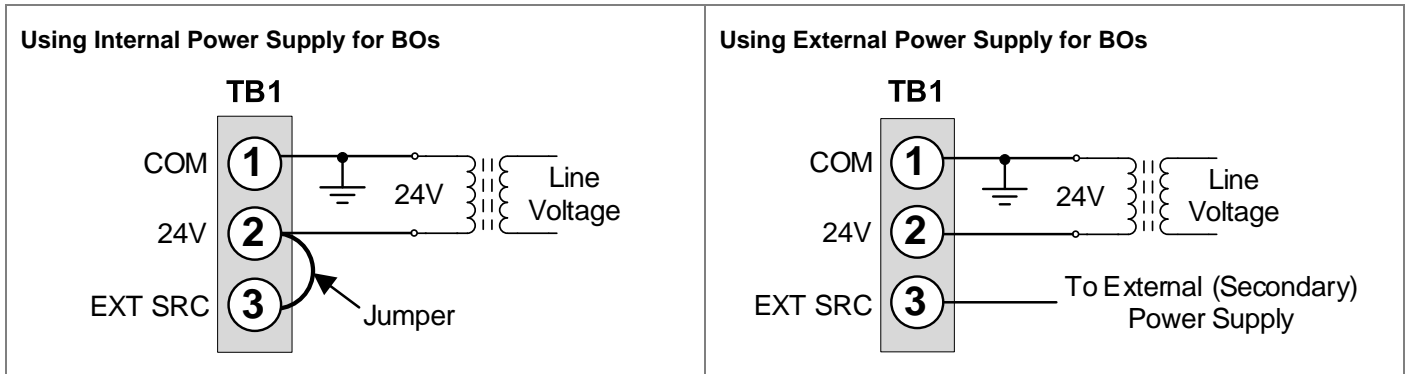

Interface

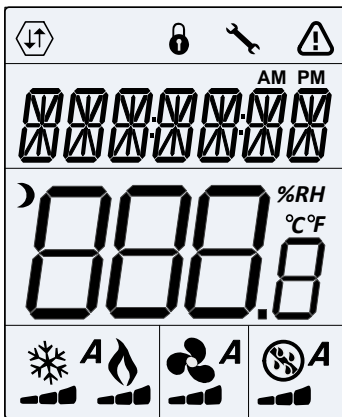

	Network Communication		User Lock		Programming Mode (Technician Setting)
	Alarm Status		Energy Saving Mode (NSB/OCC)		Time
	°C: Celsius Scale °F: Fahrenheit Scale %RH: Humidity		A Automatic Mode		Cooling
	Heating		Fan		Humidify/De-humidify

Mounting Instructions

CAUTION: Remove power to avoid a risk of malfunction.

- Remove the captive screw that's holding the base and the front cover of the unit together.
- Lift the front cover of the unit to separate it from the base.
- Pull all wires through the holes in the base.
- Secure the base to the wall using wall anchors and screws (supplied). Make the appropriate connections.
- Mount the control module on the base and secure using the screw.

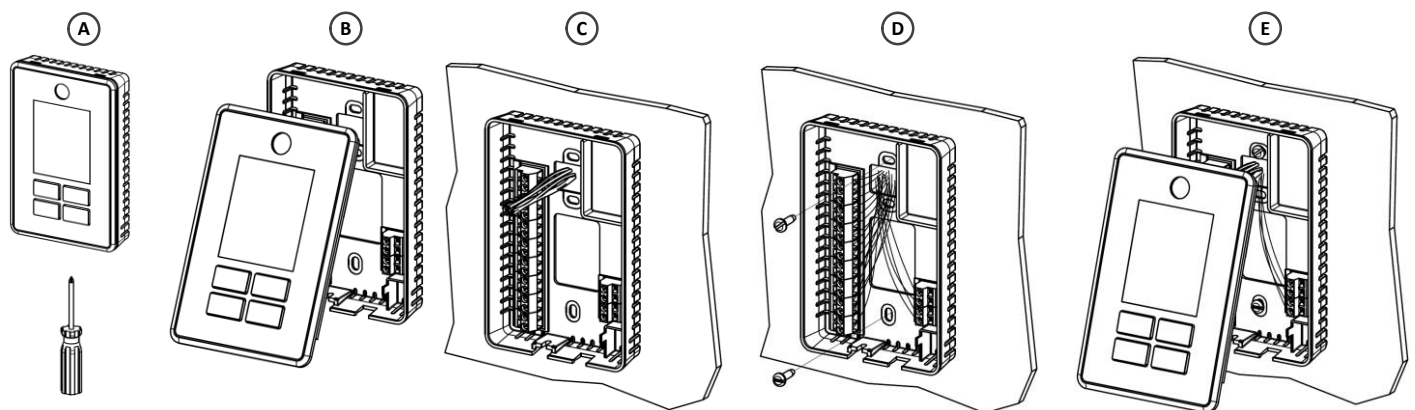

i Do not use the supplied screws to mount the unit to an electric box or an equivalent device. The supplied screws are only suitable for mounting the unit to the wall. Ensure to use the appropriate screws for any other application. Tighten by hand only and ensure not to overtighten the screws.



Programming Mode



The Mode Selector jumper JP1 must be set to the PGM position (Programming Mode). Refer to the Wiring section on page 3. To exit, set the jumper back to the RUN position (Operation Mode). Advance to the next or return to the previous setting in order to save a changed value.

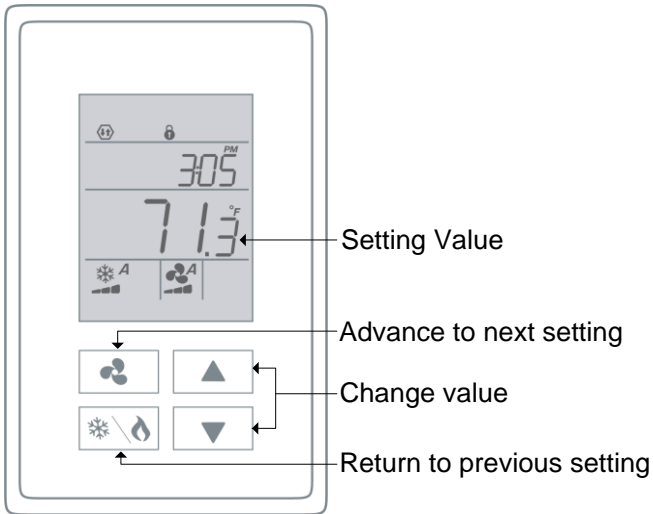

Symbols used in this Manual

Icon	Description	Icon	Description	Icon	Description	Icon	Description
	Temperature		Heating		Cooling		Humidity
	Fan		Analog Output 1		Analog Output 2		Analog Output 3
	Analog Output 4		Time		Binary Output 1		Binary Output 2
	Binary Output 3		Binary Output 4		Binary Output 5		Binary Output 6
	Binary Output 7		Universal Input 1		Universal Input 2		Universal Input 3
	Universal Input 4		Night Set Back		Occupancy		Communication
	Valve		Carbon Dioxide		Lock		



Setpoint and User Control

1. "INTERNTEMP SENSOR OFFSET"



Range:	0°C to 50°C	[32°F to 122°F]
Offset:	Max. ± 5°C	[± 9°F]
Increment:	0.1°C	[0.2°F]

Compare the displayed temperature reading with a known value from a thermometer or other temperature sensing device. To offset or calibrate the sensor, use the arrow buttons to set the desired temperature reading. This is useful for controllers installed in areas where the temperature read is slightly different than the room's actual temperature. For example, a controller placed right under the air diffuser.

2. "USER SETPNT MINIMUM"



Default:	15°C	[59°F]
Range:	10°C to 40°C	[50°F to 104°F]
Increment:	0.5°C	[1.0°F]

In Operation mode, you cannot decrease the setpoint to less than the value set as the minimum user point. The minimum value is restricted by the maximum value set at Step 3, "User Setpnt Maximum". In other words, the value that is set as the minimum cannot be greater than the maximum value.

3. "USER SETPNT MAXIMUM"



Default:	30°C	[86°F]
Range:	10°C to 40°C	[50 to 104°F]
Increment:	0.5°C	[1.0°F]

In Operation mode, you cannot increase the setpoint to more than the value set as the maximum user point. The maximum value is restricted by the minimum value set at Step 2, "User Setpnt Minimum". In other words, the value that is set as the maximum cannot be less than the minimum value.

4. "USER SETPNT LOCKED"



Default:	No (Unlocked)
Range:	No (Unlocked), yES (Locked)

If set to **No**, the user setpoint option is not locked and the user can adjust the desired temperature setpoint. If set to **yES**, the user setpoint option is locked and the user cannot set the desired temperature setpoint. A lock symbol appears to indicate that the setpoint is locked.

5. "USER SETPNT"



Default:	22°C	[72°F]
Range:	10°C to 40°C	[50°F to 104°F]
Increment:	0.5°C	[1.0°F]

Set the desired temperature setpoint within the defined range. If the setpoint option was locked at Step 4, "User Setpnt locked", a lock symbol is displayed. The setpoint value is restricted by the minimum at Step 2, "User Setpnt Minimum" and maximum at Step 3, "User Setpnt Maximum" values. In other words, the setpoint should be within the minimum and maximum setpoint range.

6. "TEMP CONTROL MODE"



Default:	Auto (Automatic)
Range:	Auto (Automatic), HEAt (Heating Only), COOL (Cooling Only), On (Cooling or Heating), CLHt (Automatic only)

Select the control mode that you want to authorize to the user. To authorize all the available modes, select Auto (Automatic Mode). The cooling and heating symbols are also displayed. The selection made at this step determines the options available via the Control Mode (see page 38).

7. "ENABLE ON OFF CONTROL MODE"



Default:	yES (Enable)
Range:	yES (Enable), No (Disable)

If set to **yES**, the user can set the unit to "Off" via the Control Mode (see page 38). If set to **No**, the "Off" selection does not appear in the Control Mode.

8. "DISPLAY INFO"



Default:	t - Hu %RH °C (temperature, humidity, and cooling heating demand)
Range:	t - Hu %RH °C (temperature, humidity), StP %RH °C (temperature, humidity setpoint), OFF (no display), t - Hu %RH °C (temperature, humidity, and cooling heating demand), StP %RH °C (temperature, humidity setpoint, and cooling heating demand)

Select the desired information to appear on the display.



Keypad Lock Settings

9. "KEYPAD UPPER LEFT LOCKED"



Default: No (Disable)
Range: yES (Enable), No (Disable)

If set to **yES**, the button is locked and cannot be used by the user. If set to **No**, the button is unlocked and can be used by the user.

10. "KEYPAD LOWER LEFT LOCKED"



Default: No (Disable)
Range: yES (Enable), No (Disable)

If set to **yES**, the button is locked and cannot be used by the user. If set to **No**, the button is unlocked and can be used by the user.

11. "KEYPAD ARROWS LOCKED"



Default: No (Disable)
Range: yES (Enable), No (Disable)

If set to **yES**, the and buttons are locked and cannot be used by the user. If set to **No**, the and buttons are unlocked and can be used by the user.

Heat Pump Settings

12. "HEAT PUMP OPTION"



Default: OFF (Disable)
Range: ON (Enable), OFF (Disable)

Enable or disable the heat pump option.

If you select **OFF**:

- Heat Pump options (Steps 13 to 15 and 49) will not be available.
- Binary Output ramps (Steps 50, 57, 63, 70, 76 and 82) will be available.

If you select **ON**:

- Heat Pump options (Steps 13 to 15 and 49) will be available.
- Binary Output ramps (Steps 50 to 57, 63, 70, 76 and 82) will not be available.

13. "REVERS VALVE O/B"



Default: o
Range: o, b

This option appears only if you have selected **ON** at Step 12, "Heat Pump Option". Set the mode in which the reversing valve is energized; cooling mode (o) or heating mode (b). The cooling symbol is displayed if you select **o** and heating symbol is displayed if you select **b**.

14. "EMH OUTPUT"



Default: dIS (Disable)
Range: dIS (Disable), ENA (Enable)

This option appears only if you have selected **ON** at Step 12, "Heat Pump Option". Select **ENA** to enable emergency heat (EMH) outputs W1 and W2, and the EMH option via the Control Mode (see page 38). Select **dIS** to disable EMH availability. The heating symbol is also displayed.

If you select **dIS**, Step 15, "EMH Auto Mode" will not be available.

If you select **ENA**, Step 15, "EMH Auto Mode" will be available.

15. "EMH AUTO MODE"



Default: NO (Disable)
Range: YES (Enable), NO (Disable)

This option appears only if you have selected **ENA** at Step 14, "EMH Output". If you select **YES**, the emergency heat (EMH) will be operational in Automatic mode. If you select **NO**, the EMH will not be operational in Automatic mode. The heating symbol is also displayed.



Valve Settings

16. "VALVE SIZE"



Default: 1"
Range: 1/2", 3/4", 1"

Select the desired valve size in inches for the 6-way valve from the available options.

Analog Output 1 (AO1)

17. "AO1 RAMP"



Default: Cr1 (Cooling Ramp 1)
Range: Cr1, Cr2, Hr1, Hr2 (heat with fan), Hr2 (heat without fan), CH1, HU, CO2, 6W, dto, VFdt, VFdP, OFF, COr

Select the desired signal from the available options.

- Cr1 (Cooling Ramp 1) or Cr2 (Cooling Ramp 2). The Cr1 and Cr2 ramps are used for cooling. If selected, the controller performs cooling based on the cooling proportional, integral, and dead band values.
- Hr1, Hr2 (heat with fan), or Hr2 (heat without fan). The Hr1 and Hr2 ramps are used for heating. If selected, the controller performs heating based on the heating proportional, integral, and dead band values.
- CH1 (Cooling and Heating). If selected, the controller performs cooling regularly. If another output is set to heat, it performs heating regularly.
- HU (Humidify). If selected, the controller modulates the output based on the humidify demand.
- CO2 (Carbon dioxide). If selected, the controller will activate or deactivate the output based on carbon dioxide levels.
- 6W (6-way Valve). If selected, the controller will modulate the 6-way valve depending on the heating or cooling demand.
- dto (Delta temperature control). If selected, the controller will modulate the ΔT control based on the inlet and outlet temperature of the water inside the fan coil unit.
- VFdt (VFD Temp Loop). If selected, the controller will modulate the VFD fan based on the selected temperature input.
- VFdP (VFD Pressure Loop). If selected, the controller will modulate the static pressure based on the reading and the pressure setpoint.
- OFF. If selected, the controller does not use the output.
- COr (Changeover). If selected, the controller will modulate heating and cooling, as appropriate.

If you select **OFF**, Steps 0 to 22 will not be available.

If you select **VFdt** or **VFdP**, Steps 42 to 48 will not be available.

If you select **CH1**, Step 41, "Minimum Cool 1 Heat 1 Percent" will be available.

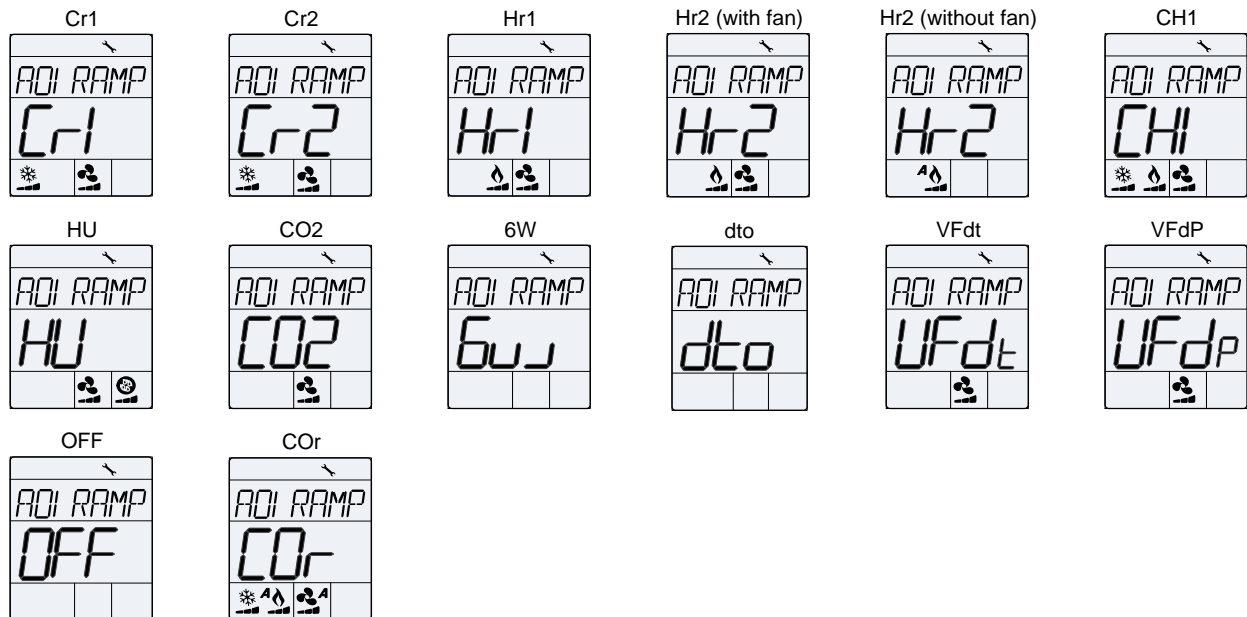



18. "AO1 MINIMUM VOLTAGE"

AO1	Default:	0.0 Volt
	Range:	0.0 to 10.0 Volts
	Increment:	0.1 Volt

This option does not appear if the signal ramp for AO1 is set to **OFF** (Step 17, "AO1 Ramp"). Select the desired minimum voltage ("zero" value) for the AO1 ramp. The minimum value is restricted by the maximum value at Step 19 "AO1 Maximum Voltage" In other words, the minimum value should be less than the maximum value.

19. "AO1 MAXIMUM VOLTAGE"

AO1	Default:	10.0 Volt
	Range:	0.0 to 10.0 Volts
	Increment:	0.1 Volt

This option does not appear if the signal ramp for AO1 is set to **OFF** (Step 17, "AO1 Ramp"). Select the desired minimum voltage ("span" value) for the AO1 ramp. The maximum value is restricted by the minimum value at Step 18, "AO1 Minimum Voltage". In other words, the maximum value should not be less than the minimum value.

20. "AO1 OFF VOLTAGE"

AO1	Default:	MIN (Minimum voltage)
	Range:	MIN (Minimum voltage), OFF (0 Volt)

This option does not appear if the signal ramp for AO1 is set to **OFF** (Step 17, "AO1 Ramp"). Select the analog output voltage when the controller is turned off. When set to MIN, the output will remain at the minimum voltage level defined at Step 18, "AO1 Minimum Voltage". When set to OFF, the output will remain at 0V.

21. "AO1 DIRREV"

AO1	Default:	dir (Direct)
	Range:	dir (Direct), rEV (Reverse)

This option does not appear if the signal ramp for AO1 is set to **OFF** (Step 17, "AO1 Ramp"). Set the direction of the analog signal to either Direct (e.g. 0 to 10Vdc), or Reverse (e.g. 10 to 0Vdc).

22. "AO1 SIGNAL TYPE"

AO1	Default:	ANLg (Analog Output)
	Range:	ANLg (Analog Output), OnOF (On/Off), PuLs (Pulsing)

This option does not appear if the signal ramp for AO1 is set to **OFF** (Step 17, "AO1 Ramp"). Set the signal type for AO1 to either Analog Output, On/Off or Pulsing.

Analog Output 2 (AO2)

23. "AO2 RAMP"

AO2	Default:	Hr1 (Heating Ramp 1)
	Range:	Cr1, Cr2, Hr1, Hr2 (heat with fan), Hr2 (heat without fan), CH1, HU, CO2, 6W, dto, VFdt, VFdP, FAN, OFF, COr

Select the desired signal from the available options. The AO1 input signal has priority over AO2.

- *Cr1 (Cooling Ramp 1) or Cr2 (Cooling Ramp 2). The Cr1 and Cr2 ramps are used for cooling. If selected, the controller performs cooling based on the cooling proportional, integral, and dead band values.*
- *Hr1, Hr2 (heat with fan), or Hr2 (heat without fan). The Hr1 and Hr2 ramps are used for heating. If selected, the controller performs heating based on the heating proportional, integral, and dead band values.*
- *CH1 (Cooling and Heating). If selected, the controller performs cooling regularly. If another output is set to heat, it performs heating regularly.*
- *HU (Humidify). If selected, the controller modulates the output based on the humidify demand.*
- *CO2 (Carbon dioxide). If selected, the controller will activate or deactivate the output based on carbon dioxide levels.*
- *6W (6-way Valve). If selected, the controller will modulate the 6-way valve depending on the heating or cooling demand.*
- *dto (Delta temperature control). If selected, the controller will modulate the ΔT control based on the inlet and outlet temperature of the water inside the fan coil unit.*
- *VFdt (VFD Temp Loop). If selected, the controller will modulate the VFD fan based on the selected temperature input.*
- *VFdP (VFD Pressure Loop). If selected, the controller will modulate the static pressure based on the reading and the pressure setpoint.*
- *FAN. The FAN option is available only if you selected **OFF** at Step 12, "Heat Pump Option". If selected, the controller modulates the output based on the Fan demand.*
- *OFF. If selected, the controller does not use the output.*



- **CO_r** (Changeover). If selected, the controller will modulate heating and cooling, as appropriate.

If you select **OFF**, Steps 24 to 28 will not be available.

If you select **VFdt** or **VFdP**, Steps 42 to 48 will not be available.

If you select **CH1**, Step 41, "Minimum Cool 1 Heat 1 Percent" will be available.

If you select **FAN**, Step 42, "Fan Spd Signal" will not be available.

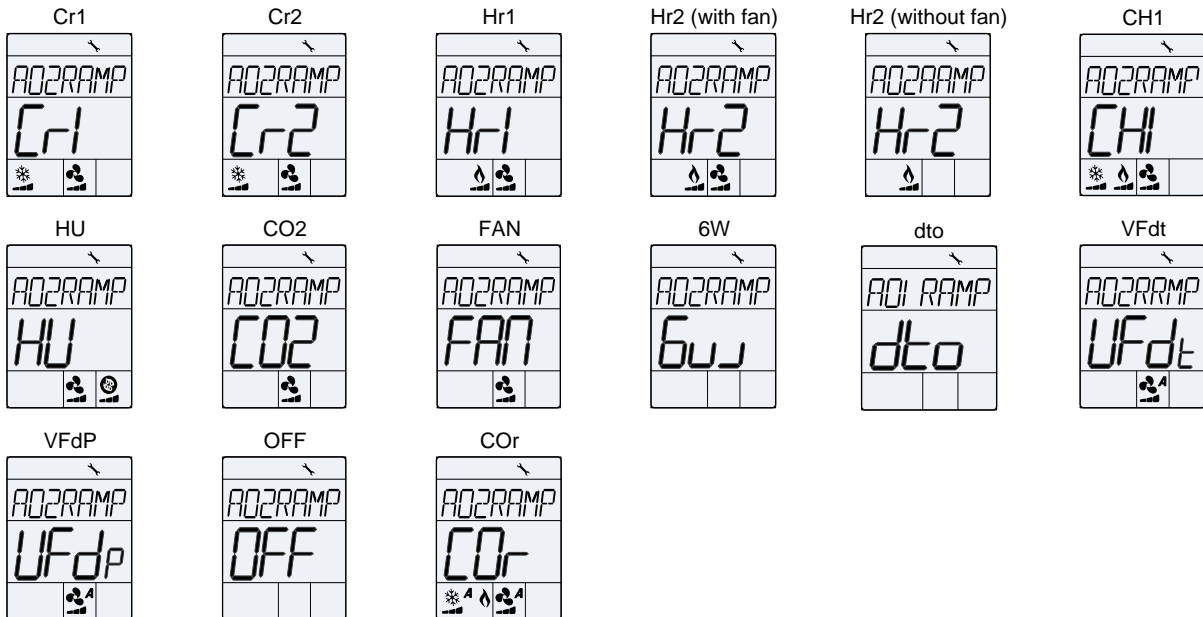

24. "AO2 MINIMUM VOLTAGE"

- AO2** Default: 0.0 Volt
- Range: 0.0 to 10.0 Volts
- Increment: 0.1 Volt

This option does not appear if the signal ramp for AO2 is set to **OFF** (Step 23, "AO2 Ramp"). Select the desired minimum voltage ("zero" value) for the AO2 ramp. The minimum value is restricted by the maximum value at Step 25, "AO2 Maximum Voltage". In other words, the minimum value should be less than the maximum value.

25. "AO2 MAXIMUM VOLTAGE"

- AO2** Default: 10.0 Volts
- Range: 0.0 to 10.0 Volts
- Increment: 0.1 Volt

This option does not appear if the signal ramp for AO2 is set to **OFF** (Step 23, "AO2 Ramp"). Select the desired maximum voltage ("span" value) for the AO2 ramp. The maximum value is restricted by the minimum value at Step 24, "AO2 Minimum Voltage". In other words, the maximum value should not be less than the minimum value.

26. "AO2 OFF VOLTAGE"

- AO2** Default: MIN (Minimum voltage)
- Range: MIN (Minimum voltage), OFF (0 Volt)

This option does not appear if the signal ramp for AO2 is set to **OFF** (Step 23, "AO2 Ramp"). Set the analog output voltage when the controller is turned off. When set to MIN, the output will remain at the minimum voltage level defined by Step 24, "AO2 Minimum Voltage". When set to OFF, the output will remain at 0V.

27. "AO2 DIRREV"

- AO2** Default: dir (Direct)
- Range: dir (Direct), rEV (Reverse)

This option does not appear if the signal ramp for AO2 is set to **OFF** (Step 23, "AO2 Ramp"). Set the direction of the analog signal to either Direct (e.g. 0 to 10Vdc), or Reverse (e.g. 10 to 0Vdc).

28. "AO2 SIGNAL TYPE"

- AO2** Default: ANLg (Analog Output)
- Range: ANLg (Analog Output), OnOF (On/Off), PuLs (Pulsing)

This option does not appear if the signal ramp for AO2 is set to **OFF** (Step 23, "AO2 Ramp"). Set the signal type for AO2 to either Analog Output, On/Off or Pulsing.



Analog Output 3 (AO3)

29. "AO3 RAMP"



Default: Hr1 (Heating Ramp 1)
Range: Cr1, Cr2, Hr1, Hr2 (heat with fan), Hr2 (heat without fan), CH1, HU, CO2, 6W, dto, OFF, COr

Select the desired signal from the available options. The AO1 and AO2 input signals have priority over AO3.

- Cr1 (Cooling Ramp 1) or Cr2 (Cooling Ramp 2). The Cr1 and Cr2 ramps are used for cooling. If selected, the controller performs cooling based on the cooling proportional, integral, and dead band values.
- Hr1, Hr2 (heat with fan), or Hr2 (heat without fan). The Hr1 and Hr2 ramps are used for heating. If selected, the controller performs heating based on the heating proportional, integral, and dead band values.
- CH1 (Cooling and Heating). If selected, the controller performs cooling regularly. If another output is set to heat, it performs heating regularly.
- HU (Humidify). If selected, the controller modulates the output based on the humidify demand.
- CO2 (Carbon dioxide). If selected, the controller will activate or deactivate the output based on carbon dioxide levels.
- 6W (6-way Valve). If selected, the controller will modulate the 6-way valve depending on the heating or cooling demand.
- dto (Delta temperature control). If selected, the controller will modulate the ΔT control based on the inlet and outlet temperature of the water inside the fan coil unit.
- OFF. If selected, the controller does not use the output.
- COr (Changeover). If selected, the controller will modulate heating and cooling, as appropriate.

If you select **OFF**, Steps 30 to 34 will not be available.

If you select **CH1**, Step 41, "Minimum Cool 1 Heat 1 Percent" will be available.

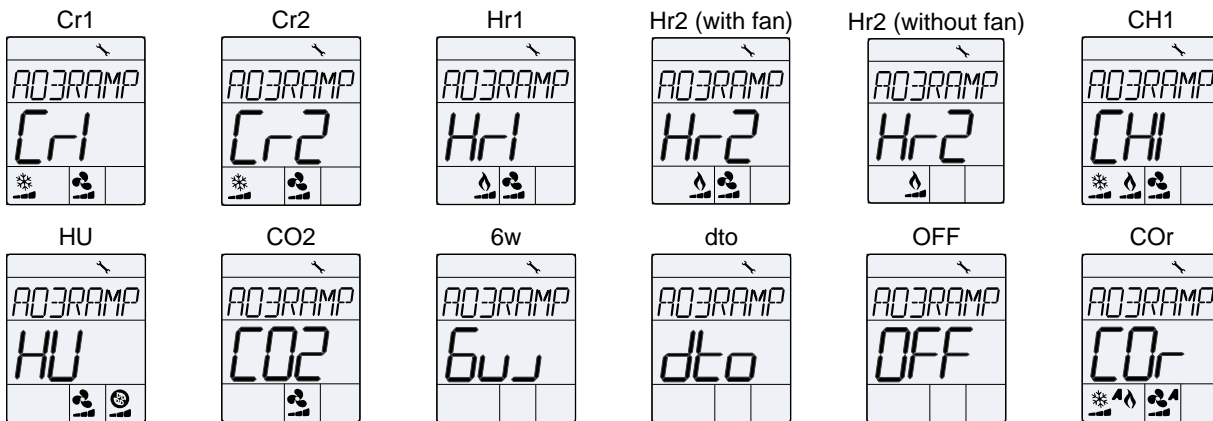

30. "AO3 MINIMUM VOLTAGE"



Default: 0.0 Volt
Range: 0.0 to 10.0 Volts
Increment: 0.1 Volt

This option does not appear if the signal ramp for AO3 is set to **OFF** (Step 29, "AO3 Ramp"). Select the desired minimum voltage ("zero" value) for the AO3 ramp. The minimum value is restricted by the maximum value at Step 31, "AO3 Maximum Voltage". In other words, the minimum value should be less than the maximum value.

31. "AO3 MAXIMUM VOLTAGE"



Default: 10.0 Volts
Range: 0.0 to 10.0 Volts
Increment: 0.1 Volt

This option does not appear if the signal ramp for AO3 is set to **OFF** (Step 29, "AO3 Ramp"). Select the desired maximum voltage ("span" value) for the AO3 ramp. The maximum value is restricted by the minimum value at Step 30, "AO3 Minimum Voltage". In other words, the maximum value should not be less than the minimum value.

32. "AO3 OFF VOLTAGE"



Default: MIN (Minimum voltage)
Range: MIN (Minimum voltage), OFF (0 Volt)

This option does not appear if the signal ramp for AO3 is set to **OFF** (Step 29, "AO3 Ramp"). Set the analog output voltage when the controller is turned off. When set to MIN, the output will remain at the minimum voltage level defined by Step 30, "AO3 Minimum Voltage". When set to OFF, the output will remain at 0V.



33. "AO3 DIRREV"

AO3 Default: dir (Direct)
Range: dir (Direct), rEV (Reverse)

This option does not appear if the signal ramp for AO3 is set to **OFF** (Step 29, "AO3 Ramp"). Set the direction of the analog signal to either Direct (e.g. 0 to 10Vdc), or Reverse (e.g. 10 to 0Vdc).

34. "AO3 SIGNAL TYPE"

AO3 Default: ANLg (Analog Output)
Range: ANLg (Analog Output), OnOF (On/Off), PuLs (Pulsing)

This option does not appear if the signal ramp for AO3 is set to **OFF** (Step 29, "AO3 Ramp"). Set the signal type for AO3 to either Analog Output, On/Off or Pulsing.

Analog Output 4 (AO4)

35. "AO4 RAMP"

AO4 Default: Hr1 (Heating Ramp 1)
Range: Cr1, Cr2, Hr1, Hr2 (heat with fan), Hr2 (heat without fan), CH1, HU, CO2, 6w, dto, OFF, COr

Select the desired ramp from the available options. Same as AO3 options. The AO1, AO2 and AO3 input signals have priority over AO4.

If you select **OFF**, Steps 36 to 40 will not be available.

36. "AO4 MINIMUM VOLTAGE"

AO4 Default: 0.0 Volt
Range: 0.0 to 10.0 Volts
Increment: 0.1 Volt

This option does not appear if the signal ramp for AO4 is set to **OFF** (Step 35, "AO4 Ramp"). Select the desired minimum voltage ("zero" value) for the AO4 ramp. The minimum value is restricted by the maximum value at Step 37, "AO4 Maximum Voltage". In other words, the minimum value should be less than the maximum value.

37. "AO4 MAXIMUM VOLTAGE"

AO4 Default: 10.0 Volts
Range: 0.0 to 10.0 Volts
Increment: 0.1 Volt

This option does not appear if the signal ramp for AO4 is set to **OFF** (Step 35, "AO4 Ramp"). Select the desired maximum voltage ("span" value) for the AO4 ramp. The maximum value is restricted by the minimum value at Step 36, "AO4 Minimum Voltage". In other words, the maximum value should not be less than the minimum value.

38. "AO4 OFF VOLTAGE"

AO4 Default: MIN (Minimum voltage)
Range: MIN (Minimum voltage), OFF (0 Volt)

This option does not appear if the signal ramp for AO4 is set to **OFF** (Step 35, "AO4 Ramp"). Set the analog output voltage when the controller is turned off. When set to MIN, the output will remain at the minimum voltage level defined by Step 36, "AO4 Minimum Voltage". When set to OFF, the output will remain at 0V.

39. "AO4 DIRREV"

AO4 Default: dir (Direct)
Range: dir (Direct), rEV (Reverse)

This option does not appear if the signal ramp for AO4 is set to **OFF** (Step 35, "AO4 Ramp"). Set the direction of the analog signal to either Direct (e.g. 0 to 10Vdc), or Reverse (e.g. 10 to 0Vdc).

40. "AO4 SIGNAL TYPE"

AO4 Default: ANLg (Analog Output)
Range: ANLg (Analog Output), OnOF (On/Off), PuLs (Pulsing)

This option does not appear if the signal ramp for AO4 is set to **OFF** (Step 35, "AO4 Ramp"). Set the signal type of the AO4 to either Analog Output, On/Off or Pulsing.



41. "MINIMUM COOL HEAT PERCENT"



Default: 0 %
Range: 0 to 100%
Increment: 5 %

This option appears if you have selected **CH1** at Step 17, "AO1 Ramp", Step 23, "AO2 Ramp", Step 29, "AO3 Ramp" or Step 35, "AO4 Ramp". Set the percentage at which the controller sets the CH1 output during heating, provided another output has also been set to heating.

Fan Settings

42. "FAN SPD SIGNAL"



Default: 3
Range: 1, 2, 3

This option does not appear if you have selected **FAN** at Step 23, "AO2 Ramp". Select the desired number of fan speed contacts. The fan symbol is also displayed.

43. "FAN SPEED OPTION"



Default: Std (Standard)
Range: AdV (Advanced), Std (Standard)

Select between the Standard (Neptronic) and Advanced (OE1) fan speed specifications. The fan symbol is also displayed.

44. "ENABLE FAN CONTRL MODE"



Default: No (Disable)
Range: yES (Enable), No (Disable)

This option appears only if you have selected **Adv** at Step 43, "Fan Speed Option". Select to enable or disable the fan control mode option. If you select **No**, the Fan Speed Selection Mode option is not available in Control Mode. The fan symbol is also displayed.

45. "HIDE FAN DISPLAY INFO"



Default: No (Disable)
Range: yES (Enable), No (Disable)

Select to enable or disable the fan display information. If you select **Yes**, the Fan demand (fan icon) does not appear on the display and the Fan Speed Selection Mode is disabled. The fan symbol is also displayed.

46. "FAN AUTO MODE"



Default: yES (Enable)
Range: yES (Enable), No (Disable)

If set to **yES**, the user can set the fan speed to "Automatic" via the Fan Speed Selection Mode (see page 39). If set to **No**, the "Automatic" speed does not appear in the Fan Speed Selection Mode. The fan symbol is also displayed.

If you select **yES**, Step 47, "Fan Auto Timeout Seconds" will be available.

If you select **No**, Step 47, "Fan Auto Timeout Seconds" will not be available.

47. "FAN AUTO TIMEOUT SECONDS"



Default: 120 seconds
Range: 0 to 255 seconds
Increment: 1 second

This option appears only if you have selected **yES** at Step 46, "Fan Auto Mode". Select the desired value for the automatic shutoff delay when there is no demand. The fan symbol is also displayed.

48. "DAMPING FACTOR TIME IN SECONDS"



Default: 0 second
Range: 0 to 255 seconds
Increment: 1 second

Select the desired damping factor value for the fan. The fan symbol is also displayed.

49. "Y2 OUTPUT"



Default: dIS (Disable)
Range: dIS (Disable), ENA (Enable)

This option appears if you have selected **ON** at Step 12, "Heat Pump Option" and fan speed of 1 or 2 at Step 42, "Fan Spd Signal". Select **ENA** to enable the compressor Y2 output and **dIS** to disable compressor Y2 output.



Binary Output 1 (BO1)

The Binary Output 1 settings do not appear if you selected ON at Step 12, "Heat Pump Option".

50. "BO1 RAMP"

BO1 Default: Cr1 (Cooling Ramp 1)
 Range: Cr1, Cr2, Hr1, Hr2 (heat with fan), Hr2 (heat without fan), CH1, HU, CO2, OFF, COr

Select the desired ramp from the available options.

- Cr1 (Cooling Ramp 1) or Cr2 (Cooling Ramp 2). The Cr1 and Cr2 ramps are used for cooling. If selected, the controller performs cooling based on the cooling proportional, integral, and dead band values.
- Hr1, Hr2 (heat with fan), or Hr2 (heat without fan). The Hr1 and Hr2 ramps are used for heating. If selected, the controller performs heating based on the heating proportional, integral, and dead band values.
- CH1 (Cooling and Heating). If selected, the controller performs cooling regularly. If another output is set to heat, it performs heating regularly.
- HU (Humidify). If selected, the controller modulates the output based on the humidify demand.
- CO2 (Carbon dioxide). If selected, the controller will activate or deactivate the output based on carbon dioxide levels.
- OFF. If selected, the controller does not use the output.
- COr (Changeover). If selected, the controller will modulate heating and cooling, as appropriate.

If you select OFF, Steps 51 to 56 will not be available.

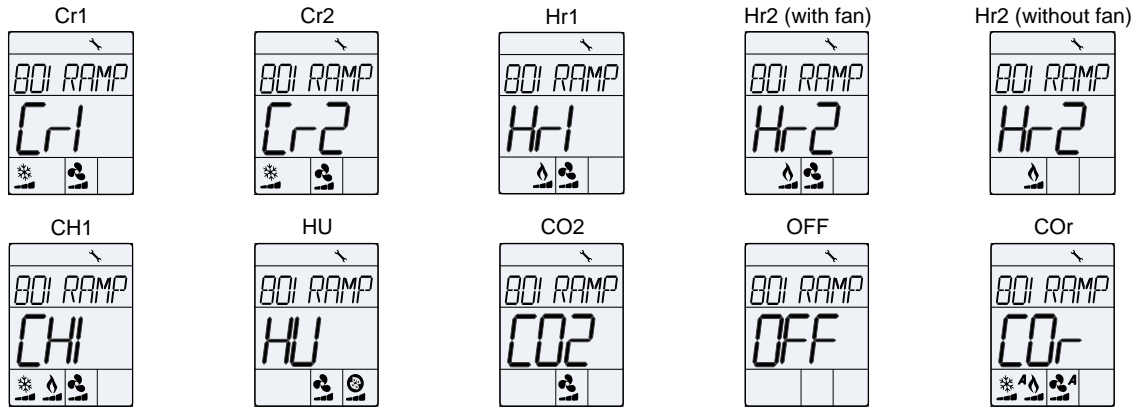

51. "BO1 SIGNAL TYPE"

BO1 Default: OnOF (On/Off)
 Range: tPm (Pulsing), OnOF(On/Off), FLOt (Floating)

This option does not appear if the signal ramp for BO1 is set to OFF (Step 50, "BO1 Ramp"). Select the signal type for BO1 to either Pulsing, On/Off or Floating.

52. "BO1 FLOAT TIMER SECONDS"

BO1 Default: 100 seconds
 Range: 15 to 250 seconds
 Increment: 5 seconds

This option only appears if the signal type for BO1 is set to FLOt (Step 51, "BO1 Signal Type"). Set the time required for the valve actuator to complete a stroke.

53. "BO1 CLOSE PERCENT"

BO1 Default: 20% of the demand
 Range: 15 to 80%
 Increment: 1%

This option does not appear if the signal ramp for BO1 is set to OFF (Step 50, "BO1 Ramp") and if the signal type for BO1 is set to either tPm or FLOt (Step 51, "BO1 Signal Type"). Select the percentage at which you want BO1 to close (at % of demand of the ramp selected at Step 50, "BO1 Ramp").

54. "BO1 OPEN PERCENT"

BO1 Default: 0% of the demand
 Range: 0 to (BO1 Close)-4%
 Increment: 1%

This option does not appear if the signal ramp for BO1 is set to OFF (Step 50, "BO1 Ramp") and if the signal type for BO1 is set to either tPm or FLOt (Step 51, "BO1 Signal Type"). Select the percentage at which you want BO1 to open (at % of demand of the ramp selected at Step 50, "BO1 Ramp").



55. "BO1 DIRREV"

BO1 Default: dir (Direct)
Range: dir (Direct), rEV (Reverse)

This option does not appear if the signal ramp for BO1 is set to **OFF** (Step 50, "BO1 Ramp") and if the signal type for BO1 is set to either **tPm** or **FLOt** (Step 51, "BO1 Signal Type"). Set the direction of the binary signal to either Direct or Reverse.

56. "BO1 CONTACT DELAY MINUTES"

BO1 Default: 0 minute
Range: 0 to 15 minutes
Increment: 1 minute

This option does not appear if the signal ramp for BO1 is set to **OFF** (Step 50, "BO1 Ramp") and if the signal type for BO1 is set to either **tPm** or **FLOt** (Step 51, "BO1 Signal Type"). Select the closing delay for BO1 output.

Binary Output 2 (BO2)

The Binary Output 2 settings do not appear if the BO1 signal type is set to **FLOt** at Step 51, "BO1 Signal Type".

57. "BO2 RAMP"

BO2 Default: Hr1 (Heating Ramp 1)
Range: Cr1, Cr2, Hr1, Hr2 (heat with fan), Hr2 (heat without fan), CH1, HU, CO2, OFF, COr

This option does not appear if you selected **ON** at Step 12, "Heat Pump Option". Select the desired ramp from the available options. Same as BO1 options.

If you select **OFF**, Steps 58 to 62 will not be available.

58. "BO2 SIGNAL TYPE"

BO2 Default: OnOF (On/Off)
Range: tPm (Pulsing), OnOF (On/Off)

This option does not appear if the signal ramp for BO2 is set to **OFF** (Step 57, "BO2 Ramp"). Select the signal type for BO2 to either Pulsing or On/Off.

59. "BO2 CLOSE PERCENT"

BO2 Default: 25% of the demand
Range: 15 to 80%
Increment: 1%

This option does not appear if the signal ramp for BO2 is set to **OFF** (Step 57, "BO2 Ramp") and if the signal type for BO2 is set to **tPm** (Step 58, "BO2 Signal Type"). Select the percentage at which you want BO2 to close (at % of demand of the ramp selected at Step 57, "BO2 Ramp").

60. "BO2 OPEN PERCENT"

BO2 Default: 0% of the demand
Range: 0 to (BO2 Close)-4%
Increment: 1%

This option does not appear if the signal ramp for BO2 is set to **OFF** (Step 57, "BO2 Ramp") and if the signal type for BO2 is set to **tPm** (Step 58, "BO2 Signal Type"). Select the percentage at which you want BO2 to open (at % of demand of the ramp selected at Step 57, "BO2 Ramp").

61. "BO2 DIRREV"

BO2 Default: dir (Direct)
Range: dir (Direct), rEV (Reverse)

This option does not appear if the signal ramp for BO2 is set to **OFF** (Step 57, "BO2 Ramp") and if the signal type for BO2 is set to **tPm** (Step 58, "BO2 Signal Type"). Set the direction of the binary signal to either Direct or Reverse.

62. "BO2 CONTACT DELAY MINUTES"

BO2 Default: 0 minute
Range: 0 to 15 minutes
Increment: 1 minute

This option does not appear if the signal ramp for BO2 is set to **OFF** (Step 57, "BO2 Ramp") and if the signal type for BO2 is set to **tPm** (Step 58, "BO2 Signal Type"). Select the closing delay for BO2 output.



Binary Output 3 (BO3)

63. "BO3 RAMP"

BO3	Default:	Hr1 (Heating Ramp 1)
	Range:	Cr1, Cr2, Hr1, Hr2 (heat with fan), Hr2 (heat without fan), CH1, HU, CO2, OFF, COr

This option does not appear if you selected **ON** at Step 12, "Heat Pump Option". Select the desired ramp from the available options. Same as BO1 options.

If you select **OFF**, Steps 64 to 69 will not be available.

64. "BO3 SIGNAL TYPE"

BO3	Default:	OnOF (On/Off)
	Range:	tPm (Pulsing), OnOF (On/Off), FLOt (Floating)

This option does not appear if the signal ramp for BO3 is set to **OFF** (Step 63, "BO3 Ramp"). Select the signal type for BO3 to either Pulsing, On/Off or Floating.

65. "BO3 FLOAT TIMER SECONDS"

BO3	Default:	100 seconds
	Range:	15 to 250 seconds
	Increment:	5 seconds

This option only appears if the signal type for BO3 is set to **FLOt** (Step 64, "BO3 Signal Type"). Set the time required for the valve actuator to complete a stroke.

66. "BO3 CLOSE PERCENT"

BO3	Default:	50% of the demand
	Range:	15 to 80%
	Increment:	1%

This option does not appear if the signal ramp for BO3 is set to **OFF** (Step 63, "BO3 Ramp") and if the signal type for BO3 is set to either **tPm** or **FLOt** (Step 64, "BO3 Signal Type"). Select the percentage at which you want BO3 to close (at % of demand of the ramp selected at Step 63, "BO3 Ramp").

67. "BO3 OPEN PERCENT"

BO3	Default:	25% of the demand
	Range:	0 to (BO3 Close)-4%
	Increment:	1%

This option does not appear if the signal ramp for BO3 is set to **OFF** (Step 63, "BO3 Ramp") and if the signal type for BO3 is set to either **tPm** or **FLOt** (Step 64, "BO3 Signal Type"). Select the percentage at which you want BO3 to open (at % of demand of the ramp selected at Step 63, "BO3 Ramp").

68. "BO3 DIRREV"

BO3	Default:	dir (Direct)
	Range:	dir (Direct), rEV (Reverse)

This option does not appear if the signal ramp for BO3 is set to **OFF** (Step 63, "BO3 Ramp") and if the signal type for BO3 is set to either **tPm** or **FLOt** (Step 64, "BO3 Signal Type"). Set the direction of the binary signal to either Direct or Reverse.

69. "BO3 CONTACT DELAY MINUTES"

BO3	Default:	0 minute
	Range:	0 to 15 minutes
	Increment:	1 minute

This option does not appear if the signal ramp for BO3 is set to **OFF** (Step 63, "BO3 Ramp") and if the signal type for BO3 is set to either **tPm** or **FLOt** (Step 64, "BO3 Signal Type"). Select the closing delay for BO3 output.

Binary Output 4 (BO4)

The Binary Output 4 settings appear only if you have selected one of the following options: fan speed 1 or 2 at Step 42, "Fan Spd Signal", VFdP or VFdt at Step 17, "AO1 Ramp" or VFdP, VFdt or FAN at Step 23, "AO2 Ramp".

70. "BO4 RAMP"

BO4	Default:	OFF
	Range:	Cr1, Cr2, Hr1, Hr2 (heat with fan), Hr2 (heat without fan), CH1, HU, CO2, OFF, COr

Select the desired ramp from the available options. Same as BO1 options.

If you select **OFF**, Steps 71 to 75 will not be available.



71. "BO4 SIGNAL TYPE"

- BO4 Default: OnOF (On/Off)
- BO4 Range: tPm (Pulsing), OnOF (On/Off)

This option does not appear if the signal ramp for BO4 is set to **OFF** (Step 70, "BO4 Ramp"). Select the signal type BO4 to either Pulsing or On/Off.

72. "BO4 CLOSE PERCENT"

- BO4 Default: 20% of the demand
- BO4 Range: 15 to 80%
- BO4 Increment: 1%

This option does not appear if the signal ramp for BO4 is set to **OFF** (Step 70, "BO4 Ramp") and if the signal type for BO4 is set to **tPm** (Step 71, "BO4 Signal Type"). Select the percentage at which you want BO4 to close (at % of demand of the ramp selected at Step 70, "BO4 Ramp").

73. "BO4 OPEN PERCENT"

- BO4 Default: 0% of the demand
- BO4 Range: 0 to (BO4 Close)-4%
- BO4 Increment: 1%

This option does not appear if the signal ramp for BO4 is set to **OFF** (Step 70, "BO4 Ramp") and if the signal type for BO4 is set to **tPm** (Step 71, "BO4 Signal Type"). Select the percentage at which you want BO4 to open (at % of demand of the ramp selected at Step 70, "BO4 Ramp").

74. "BO4 DIRREV"

- BO4 Default: dir (Direct)
- BO4 Range: dir (Direct), rEV (Reverse)

This option does not appear if the signal ramp for BO4 is set to **OFF** (Step 70, "BO4 Ramp") and if the signal type for BO4 is set to **tPm** (Step 71, "BO4 Signal Type"). Set the direction of the binary signal to either Direct or Reverse.

75. "BO4 CONTACT DELAY MINUTES"

- BO4 Default: 0 minute
- BO4 Range: 0 to 15 minutes
- BO4 Increment: 1 minute

This option does not appear if the signal ramp for BO4 is set to **OFF** (Step 70, "BO4 Ramp") and if the signal type for BO4 is set to **tPm** (Step 71, "BO4 Signal Type"). Select the closing delay for BO4 output.

Binary Output 5 (BO5)

The Binary Output 5 settings appear only if you have selected one of the following options: fan speed 1 at Step 42, "Fan Spd Signal", VFdP or VFdt at Step 17, "AO1 Ramp" or VFdP, VFdt or FAN at Step 23, "AO2 Ramp".

76. "BO5 RAMP"

- BO5 Default: OFF
- BO5 Range: Cr1, Cr2, Hr1, Hr2 (heat with fan), Hr2 (heat without fan), CH1, HU, CO2, OFF, COr

Select the desired ramp from the available options. Same as BO1 options.

If you select **OFF**, Steps 77 to 81 will not be available.

77. "BO5 SIGNAL TYPE"

- BO5 Default: OnOF (On/Off)
- BO5 Range: tPm (Pulsing), OnOF (On/Off)

This option does not appear if the signal ramp for BO5 is set to **OFF** (Step 76, "BO5 Ramp"). Select the signal type for BO5 to either Pulsing or On/Off.

78. "BO5 CLOSE PERCENT"

- BO5 Default: 20% of the demand
- BO5 Range: 15 to 80%
- BO5 Increment: 1%

This option does not appear if the signal ramp for BO5 is set to **OFF** (Step 76, "BO5 Ramp") and if the signal type for BO5 is set to **tPm** (Step 77, "BO5 Signal Type"). Select the percentage at which you want BO5 to close (at % of demand of the ramp selected at Step 76, "BO5 Ramp").



79. "BO5 OPEN PERCENT"

	Default:	0% of the demand
	Range:	0 to (BO5 Close)-4%
	Increment:	1%

This option does not appear if the signal ramp for BO5 is set to **OFF** (Step 76, "BO5 Ramp") and if the signal type for BO5 is set to **tPm** (Step 77, "BO5 Signal Type"). Select the percentage at which you want BO5 to open (at % of demand of the ramp selected at Step 76, "BO5 Ramp").

80. "BO5 DIRREV"

	Default:	dir (Direct)
	Range:	dir (Direct), rEV (Reverse)

This option does not appear if the signal ramp for BO5 is set to **OFF** (Step 76, "BO5 Ramp") and if the signal type for BO5 is set to **tPm** (Step 77, "BO5 Signal Type"). Set the direction of the binary signal to either Direct or Reverse.

81. "BO5 CONTACT DELAY MINUTES"

	Default:	0 minute
	Range:	0 to 15 minutes
	Increment:	1 minute

This option does not appear if the signal ramp for BO5 is set to **OFF** (Step 76, "BO5 Ramp") and if the signal type for BO5 is set to **tPm** (Step 77, "BO5 Signal Type"). Select the closing delay for BO5 output.

Binary Output 6 (BO6)

The Binary Output 6 settings appear only if you have selected one of the following options: **VFdP** or **VFdt** at Step 17, "AO1 Ramp" or **VFdP**, **VFdt** or **FAN** at Step 23, "AO2 Ramp".

82. "BO6 RAMP"

	Default:	OFF
	Range:	Cr1, Cr2, Hr1, Hr2 (heat with fan), Hr2 (heat without fan), CH1, HU, CO2, 6w, dto, VFdt, VFdP, OFF, COr

Select the desired ramp from the available options. Same as BO1 options. The VFdt and VFdP options are available only if you have selected them at Step 17, "AO1 Ramp", Step 23, "AO2 Ramp".

If you select **OFF**, Step 83 to 87 will not be available.

- *6W (6-way Valve). If selected, the controller will modulate the 6-way valve depending on the heating or cooling demand.*
- *dto (Delta temperature control). If selected, the controller will modulate the ΔT control based on the inlet and outlet temperature of the water inside the fan coil unit.*
- *VFdt (VFD Temp Loop). If selected, the controller will modulate the VFD fan based on the selected temperature input.*
- *VFdP (VFD Pressure Loop). If selected, the controller will modulate the static pressure based on the reading and the pressure setpoint.*

83. "BO6 SIGNAL TYPE"

	Default:	OnOF (On/Off)
	Range:	tPm (Pulsing), OnOF (On/Off)

This option does not appear if the signal ramp for BO6 is set to **OFF** (Step 82, "BO6 Ramp"). Select the signal type for BO6 to either Pulsing or On/Off.

84. "BO6 CLOSE PERCENT"

	Default:	20% of the demand
	Range:	15 to 80%
	Increment:	1%

This option does not appear if the signal ramp for BO6 is set to **OFF** (Step 82, "BO6 Ramp") and if the signal type for BO6 is set to **tPm** (Step 83, "BO6 Signal Type"). Select the percentage at which you want BO6 to close (at % of demand of the ramp selected at Step 82, "BO6 Ramp").

85. "BO6 OPEN PERCENT"

	Default:	0% of the demand
	Range:	0 to (BO6 Close)-4%
	Increment:	1%

This option does not appear if the signal ramp for BO6 is set to **OFF** (Step 82, "BO6 Ramp") and if the signal type for BO6 is set to **tPm** (Step 83, "BO6 Signal Type"). Select the percentage at which you want BO6 to open (at % of demand of the ramp selected at Step 82, "BO6 Ramp").



86. "BO6 DIRREV"

BO6	Default:	dir (Direct)
	Range:	dir (Direct), rEV (Reverse)

This option does not appear if the signal ramp for BO6 is set to **OFF** (Step 82, "BO6 Ramp") and if the signal type for BO6 is set to **tPm** (Step 83, "BO6 Signal Type"). Set the direction of the binary signal to either Direct or Reverse.

87. "BO6 CONTACT DELAY MINUTES"

BO6	Default:	0 minute
	Range:	0 to 15 minutes
	Increment:	1 minute

This option does not appear if the signal ramp for BO6 is set to **OFF** (Step 82, "BO6 Ramp") and if the signal type for BO6 is set to **tPm** (Step 83, "BO6 Signal Type"). Select the closing delay for BO6 output.

Binary Output 7 (BO7)

The Binary Output 7 settings do not appear if the BO3 signal type is set to **FLOT** at Step 64, "BO3 Signal Type".

88. "BO7 RAMP"

BO7	Default:	OFF
	Range:	Cr1, Cr2, Hr1, Hr2 (heat with fan), Hr2 (heat without fan), CH1, HU, CO2, OFF, COr

Select the desired ramp from the available options. Same as BO1 options.

If you select **OFF**, Steps 89 to 93 will not be available.

89. "BO7 SIGNAL TYPE"

BO7	Default:	OnOF (On/Off)
	Range:	tPm (Pulsing), OnOF (On/Off)

This option does not appear if the signal ramp for BO7 is set to **OFF** (Step 88, "BO7 Ramp"). Select the signal type for BO7 to either Pulsing or On/Off.

90. "BO7 CLOSE PERCENT"

BO7	Default:	20% of the demand
	Range:	15 to 80%
	Increment:	1%

This option does not appear if the signal ramp for BO7 is set to **OFF** (Step 88, "BO7 Ramp") and if the signal type for BO7 is set to **tPm** (Step 89, "BO7 Signal Type"). Select the percentage at which you want BO7 to close (at % of demand of the ramp selected at Step 88, "BO7 Ramp").

91. "BO7 OPEN PERCENT"

BO7	Default:	0% of the demand
	Range:	0 to (BO6 Close)-4%
	Increment:	1%

This option does not appear if the signal ramp for BO6 is set to **OFF** (Step 88, "BO7 Ramp") and if the signal type for BO7 is set to **tPm** (Step 89, "BO7 Signal Type"). Select the percentage at which you want BO7 to open (at % of demand of the ramp selected at Step 88, "BO7 Ramp").

92. "BO7 DIRREV"

BO7	Default:	dir (Direct)
	Range:	dir (Direct), rEV (Reverse)

This option does not appear if the signal ramp for BO7 is set to **OFF** (Step 88, "BO7 Ramp") and if the signal type for BO7 is set to **tPm** (Step 89, "BO7 Signal Type"). Set the direction of the binary signal to either Direct or Reverse.

93. "BO7 CONTACT DELAY MINUTES"

BO7	Default:	0 minute
	Range:	0 to 15 minutes
	Increment:	1 minute

This option does not appear if the signal ramp for BO7 is set to **OFF** (Step 88, "BO7 Ramp") and if the signal type for BO7 is set to **tPm** (Step 89, "BO7 Signal Type"). Select the closing delay for BO7 output.



Proportional and Deadband Settings

94. "CH OVER PROP BAND"



Default:	2.0°C	[4°F]
Range:	0.5°C to 5.0°C	[1°F to 9°F]
Increment:	0.5°C	[1°F]

Select the desired proportional band value of the changeover ramp. The cooling ❄️ and heating 🔥 symbols are also displayed.

95. "CH OVER DEAD BAND"



Default:	0.3°C	[0.6°F]
Range:	0.0°C to 5.0°C	[0°F to 9°F]
Increment:	0.1°C	[0.2°F]

Select the desired dead band value of the changeover ramp. The cooling ❄️ and heating 🔥 symbols are also displayed.

96. "HEAT 1 PROP BAND"



Default:	2.0°C	[4°F]
Range:	0.5°C to 5.0°C	[1°F to 9°F]
Increment:	0.5°C	[1°F]

Select the desired proportional band value of the heating ramp 1. The heating 🔥 symbol is also displayed.

97. "HEAT 1 DEAD BAND"



Default:	0.3°C	[0.6°F]
Range:	0.0°C to 5.0°C	[0°F to 9°F]
Increment:	0.1°C	[0.2°F]

Select the desired dead band value of the heating ramp 1. The heating 🔥 symbol is also displayed.

98. "HEAT 2 PROP BAND"



Default:	2.0°C	[4°F]
Range:	0.5°C to 5.0°C	[1°F to 9°F]
Increment:	0.5°C	[1°F]

Select the desired proportional band value of the heating ramp 2. The heating 🔥 symbol is also displayed.

99. "HEAT 2 DEAD BAND"



Default:	0.3°C	[0.6°F]
Range:	0.0°C to 5.0°C	[0°F to 9°F]
Increment:	0.1°C	[0.2°F]

Select the desired dead band value of the heating ramp 2. The heating 🔥 symbol is also displayed.

100. "COOL 1 PROP BAND"



Default:	2.0°C	[4°F]
Range:	0.5°C to 5.0°C	[1°F to 9°F]
Increment:	0.5°C	[1°F]

Select the desired proportional band value of the cooling ramp 1. The cooling ❄️ symbol is also displayed.

101. "COOL 1 DEAD BAND"



Default:	0.3°C	[0.6°F]
Range:	0°C to 5.0°C	[0°F to 9°F]
Increment:	0.1°C	[0.2°F]

Select the desired dead band value of the cooling ramp 1. The cooling ❄️ symbol is also displayed.

102. "COOL 2 PROP BAND"



Default:	2.0°C	[4°F]
Range:	0.5°C to 5.0°C	[1°F to 9°F]
Increment:	0.5°C	[1°F]

Select the desired proportional band value of the cooling ramp 2. The cooling ❄️ symbol is also displayed.

103. "COOL 2 DEAD BAND"



Default:	0.3°C	[0.6°F]
Range:	0.0°C to 5.0°C	[0°F to 9°F]
Increment:	0.1°C	[0.2°F]

Select the desired dead band value of the cooling ramp 2. The cooling ❄️ symbol is also displayed.



104. "COOLING ANTI CYCLE MINUTES"



Default: 2 minutes
Range: 0 to 15 minutes
Increment: 1 minute

To protect the compressor, set the delay in minutes before activating or reactivating the cooling output. The cooling ❄️ symbol is also displayed.

105. "HEATING INTGRAL TIME IN SECONDS"



Default: 0 seconds
Range: 0 to 250 seconds
Increment: 5 seconds

Set the desired value for heating integration factor compensation. The heating 🔥 symbol is also displayed.

106. "COOLING INTGRAL TIME IN SECONDS"



Default: 0 seconds
Range: 0 to 250 seconds
Increment: 5 seconds

Set the desired value for cooling integration factor compensation. The cooling ❄️ symbol is also displayed.

107. "CL HT SWITCH TIMER MINUTES"



Default: 0 minutes
Range: 0 to 120 minutes
Increment: 1 minute

Time required in minutes before a changeover can take place. The cooling ❄️ and heating 🔥 symbols are also displayed.

Universal Input 1 (UI1)

108. "UI1 SIGNAL TYPE"



Default: OFF
Range: OFF, t10.0, SENs, noCL, noHt, OAS, t10V, CO2, OCC, nSb, oVrd, win, door, dFt, FLS, oVht, SEL, FrFb, HU, P10V, t012, dt1t, dt1u, dt0t, dt0u

Select the input signal type for UI1 (Universal Input 1).

- OFF. If selected, the controller does not use the input.
- t10.0. If selected, the controller uses a 10kΩ type III external temperature sensor. If you select **t10.0**, Step 126, "Extern Temp Sensor Offset" will be available.
- SENs. If selected, heating mode activates when the temperature read by the external sensor is above the Changeover Setpoint and cooling mode activates when the temperature read by the external sensor is below the Changeover Setpoint. If you select **SENs**, Step 127, "CH Over Setpnt" will be available.
- NoCL. If selected, the heating mode activates when the contact is closed and cooling mode activates when the contact is opened.
- NoHt. If selected, the cooling mode activates when the contact is closed and heating mode activates when the contact is opened.
- OAS. If selected, the controller uses a 10kΩ type III outside air sensor. Note that the temperature read cannot be used as the control temperature.
- t10v. If selected, the controller uses a 0 to 10 Vdc external temperature sensor. If you select **t10v**, Step 109, "UI1 Minimum Voltage", 124, "Extern Temp Minimum", 125, "Extern Temp Maximum", 126, "Extern Temp Sensor Offset" will be available.
- CO2. If selected, the controller uses a 0 to 10 Vdc CO₂ sensor. If you select **CO2**, Step 128, "CO2 Maximum Range" will be available.
- OCC. If selected, the controller activates the occupancy status.
- nSb. If selected, the controller activates the night set back status.
- oVrd. If selected, the controller activates an alarm to indicate that there has been an override and the controller is forced into OFF mode.
- win. If selected, the controller activates an alarm to indicate that the window is open. If you select **win**, Steps 146, "Window Open Mode" and 147, "Window Fan Mode" will be available.
- door. If selected, the controller activates an alarm to indicate that the door is open. If you select **door**, Steps 148, "Door Open Mode" and 149, "Door Fan Mode" will be available.
- dFt. If selected, the controller activates an alarm to indicate that the filter is dirty.
- FLS. If selected, the controller activates an alarm to indicate that the airflow is absent. The controller shuts off all outputs.



- *oVht*. If selected, the controller activates an alarm to indicate that the heating equipment has overheated. The controller shuts off the heating outputs.
- *SEL*. If selected, the controller activates the Local mode. The controller shuts off fan outputs.
- *FrFb*. If selected, the controller senses the pulse feedback of the ECM motor.
- *HU*. If selected, the controller activates the humidity mode.
- *P10V* (Pressure 0-10V). If selected, the controller uses a 0 to 10Vdc pressure static sensor. If you select **P10V**, Step 109, "U11 Minimum Voltage" and Step 133, "Pressur Maximum Range" will be available.
- *t012* (Extern Temp TT012). If selected, the controller uses a 10kΩ type 24 external temperature sensor. If you select **t012**, Step 126, "Extern Temp Sensor Offset" will be available.
- *dt1t* (Delta Temp Inlet 10K). If selected, the controller uses a 10K type 3 temperature sensor. The controller selects this temperature as the inlet temperature in the ΔT control mode.
- *dt1u* (Delta Temp Inlet 0-10V). If selected, the controller uses a 0 to 10 Vdc temperature sensor. The controller selects this temperature as the inlet temperature in the ΔT control mode.
- *dt0t* (Delta Temp Outlet 10K). If selected, the controller uses a 10K type 3 temperature sensor. The controller selects this temperature as the outlet temperature in the ΔT control mode.
- *dt0u* (Delta Temp Outlet 0-10V). If selected, the controller uses a 0 to 10 Vdc temperature sensor. The controller selects this temperature in the ΔT control mode.

If you select one of the following options: **OFF**, **t10.0**, **SENs**, **noCL**, **noHt**, **OAS**, **t10V**, **CO2**, **HU**, **P10V**, or **t012**, Steps 110 and 111 will not be available.



109. "U11 MINIMUM VOLTAGE"

U11 Default: 2.0
Range: 0.0, 2.0

This option appears only if you have selected either **P10V** or **t10V** at Step 108, "U11 Signal Type". Select the minimum voltage for AI1.



110. "UI1 CONTACT"

UI1 Default: NO (Normally Open)
Range: NO (Normally Open), NC (Normally Close)

This option appears only if you have selected any one of the options: **OCC, nSb, oVrd, win, door, dFt, FLS, oVht, SEL** at Step 108, "UI1 Signal Type". Select the desired contact option.

111. "UI1 DELAY SECONDS"

UI1 Default: 120 seconds
Range: 0 to 3600 seconds
Increment: 10 seconds

This option appears if you have selected any one of the options: **oVrd, win, door, dFt, FLS, oVht, SEL** at Step 108, "UI1 Signal Type". Set the delay in seconds before the state of input for UI1 is changed.

Universal Input 2 (UI2)

112. "UI2 SIGNAL TYPE"

UI2 Default: OFF
Range: OFF, t10.0, SENs, noCL, noHt, OAS, t10V, CO2, OCC, nSb, oVrd, win, door, dFt, FLS, oVht, SEL, FrFb, HU, P10V, t012, dt1t, dt1u, dt0t, dt0u

Select the input signal type for UI2 (Universal Input 2). Same options as Step 108, "UI1 Signal Type".

- The UI1 input signal has priority over UI2. If you select the same input signal type as UI1, UI2 will not be functional.

If you select one of the following options: **OFF, noCL, noHt, OAS** or **HU**, Steps 113 to 132 will not be available.

If you select **t10.0**, Steps 113 to 125 will not be available.

If you select **t10V**, Steps 114 and 115 will not be available.

If you select **SENs**, Steps 113 to 126 will not be available.

If you select **CO2**, Steps 113 to 127 and 133 to 143 will not be available.

If you select **P10V** or **t10V**, Step 113, "UI2 Minimum Voltage" will be available.

If you select **P10V**, Step 133, "Pressur Maximum Range" will be available.

113. "UI2 MINIMUM VOLTAGE"

UI2 Default: 2.0
Range: 0.0, 2.0

This option appears only if you have selected either **P10V** or **t10V** at Step 112, "UI2 Signal Type". Select the minimum voltage for UI2.

114. "UI2 CONTACT"

UI2 Default: NO (Normally Open)
Range: NO (Normally Open), NC (Normally Close)

This option appears only if you have selected any one of the options: **OCC, nSb, oVrd, win, door, dFt, FLS, oVht, SEL** at Step 112, "UI2 Signal Type". Select the desired contact option.

115. "UI2 DELAY SECONDS"

UI2 Default: 120 seconds
Range: 0 to 3600 seconds
Increment: 10 seconds

This option appears if you have selected any one of the options: **oVrd, win, door, dFt, FLS, oVht, SEL** at Step 112, "UI2 Signal Type". Set the delay in seconds before the state of input for UI2 is changed.

Universal Input 3 (UI3)

116. "UI3 SIGNAL TYPE"

UI3 Default: OFF
Range: OFF, t10.0, SENs, noCL, noHt, OAS, t10V, CO2, OCC, nSb, oVrd, win, door, dFt, FLS, oVht, SEL, FrFb, HU, P10V, t012, dt1t, dt1u, dt0t, dt0u

Select the input signal type for UI3 (Universal Input 3). Same options as Step 108, "UI1 Signal Type".

- The UI1 and UI2 input signal has priority over UI3. If you select the same input signal type as UI1 or UI2, UI3 will not be functional.

If you select one of the following options: **OFF, noCL, noHt, OAS** or **HU**, Steps 117 to 132 will not be available.



- If you select **t10.0**, Steps 117 to 125 will not be available.
- If you select **t10V**, Steps 118 and 119 will not be available.
- If you select **SEnS**, Steps 117 to 126 will not be available.
- If you select **CO2**, Steps 117 to 127 and 133 to 143 will not be available.
- If you select **P10V** or **t10V**, Step 117, "UI3 Minimum Voltage" will be available.
- If you select **P10V**, Step **133**, "Pressur Maximum Range" will be available.

117. "UI3 MINIMUM VOLTAGE"

UI3 Default: 2.0
Range: 0.0, 2.0

This option appears only if you have selected either **P10V** or **t10V** at Step 116, "U13 Signal Type". Select the minimum voltage for UI3.

118. "UI3 CONTACT"

UI3 Default: NO (Normally Open)
Range: NO (Normally Open), NC (Normally Close)

This option appears only if you have selected any one of the options: **OCC, nSb, oVrd, win, door, dFt, FLS, oVht, SEL** at Step 116, "U13 Signal Type". Select the desired contact option.

119. "UI3 DELAY SECONDS"

UI3 Default: 120 seconds
Range: 0 to 3600 seconds
Increment: 10 seconds

This option appears if you have selected any one of the options: **oVrd, win, door, dFt, FLS, oVht, SEL** at Step 116, "U13 Signal Type". Set the delay in seconds before the state of input for UI3 is changed.

Universal Input 4 (UI4)

120. "UI4 SIGNAL TYPE"

UI4 Default: OFF
Range: OFF, t10.0, SEnS, noCL, noHt, OAS, t10V, CO2, OCC, nSb, oVrd, win, door, dFt, FLS, oVht, SEL, FrFb, HU, P10V, t012, dt1t, dt1u, dt0t, dt0u

Select the input signal type for UI4 (Universal Input 4). Same options as Step 108, "UI1 Signal Type".

- *The UI1, UI2 and UI3 input signal has priority over UI4. If you select the same input signal type as UI1, UI2 and UI3, UI4 will not be functional.*

- If you select one of the following options: **OFF, noCL, noHt, OAS** or **HU**, Steps 121 to 132 will not be available.
- If you select **t10.0**, Steps 121 to 125 will not be available.
- If you select **t10V**, Steps 122 and 123 will not be available.
- If you select **SEnS**, Steps 121 to 126 will not be available.
- If you select **CO2**, Steps 121 to 127 and 133 to 143 will not be available.
- If you select **P10V** or **t10V**, Step 121, "UI3 Minimum Voltage" will be available.
- If you select **P10V**, Step **133**, "Pressur Maximum Range" will be available.

121. "UI4 MINIMUM VOLTAGE"

UI4 Default: 2.0
Range: 0.0, 2.0

This option appears only if you have selected either **P10V** or **t10V** at Step 120, "UI4 Signal Type". Select the minimum voltage for UI4.

122. "UI4 CONTACT"

UI4 Default: NO (Normally Open)
Range: NO (Normally Open), NC (Normally Close)

This option appears only if you have selected any one of the options: **OCC, nSb, oVrd, win, door, dFt, FLS, oVht, SEL** at Step 120, "UI4 Signal Type". Select the desired contact option.



123. "UI4 DELAY SECONDS"



Default: 120 seconds
Range: 0 to 3600 seconds
Increment: 10 seconds

This option appears if you have selected any one of the options: **oVrd**, **win**, **door**, **dFt**, **FLS**, **oVht**, **SEL** at Step 120, "UI4 Signal Type". Set the delay in seconds before the state of input for UI4 is changed.

Temperature Settings

124. "EXTERN TEMP MINIMUM"



Default: 0°C [32°F]
Range: -40.0°C to 0°C [-40°F to 32°F]
Increment: 0.5°C [1°F]

This option appears only if you have selected **t10V** at Step 108, "UI1 Signal Type", Step 112, "UI2 Signal Type", Step 116, "UI3 Signal Type" or Step 120, "UI4 Signal Type". Set the minimum external temperature value. The minimum value is restricted by the maximum value set at Step 125, "Extern Temp Maximum". In other words, the value that is set as the minimum cannot be greater than the maximum value.

125. "EXTERN TEMP MAXIMUM"



Default: 50°C [122°F]
Range: 50°C to 100°C [122°F to 212°F]
Increment: 0.5°C [1°F]

This option appears only if you have selected **t10V** at Step 108, "UI1 Signal Type", Step 112, "UI2 Signal Type", Step 116, "UI3 Signal Type" or Step 120, "UI4 Signal Type". Set the maximum external temperature value. The maximum value is restricted by the minimum value set at Step 124, "Extern Temp Minimum". In other words, the value that is set as the maximum cannot be less than the minimum value.

126. "EXTERN TEMP SENSOR OFFSET"



Range: -40.0°C to 100°C [-40°F to 212°F]
Offset: Max. ± 5°C [± 9°F]
Increment: 0.1°C [0.2°F]

This option appears only if you have selected **t10.0**, **t10V**, or **t012** at Step 108, "UI1 Signal Type", Step 112, "UI2 Signal Type", Step 116, "UI3 Signal Type" or Step 120, "UI4 Signal Type". The display shows the temperature read by the external temperature sensor. Adjust the offset by comparing it with a known value (e.g. thermometer). If the sensor is not connected or short circuited, the unit displays the sensor's limit.

127. "CH OVER SETPNT"



Default: 24.0°C [75°F]
Range: 10.0°C to 40.0°C [50°F to 104°F]
Increment: 0.5°C [1°F]

This option appears only if you have selected **SENs** at Step 108, "UI1 Signal Type", Step 112, "UI2 Signal Type", Step 116, "UI3 Signal Type" or Step 120, "UI4 Signal Type". Set the desired changeover temperature setpoint. Note that the heating mode activates when the temperature read by the external sensor is above the changeover setpoint and cooling mode activates when the temperature read by the external sensor is below the changeover setpoint.

CO₂ Sensor Settings

The CO₂ Sensor Settings appear only for the following conditions: if you have selected **CO2** at Step 108, "UI1 Signal Type", Step 112, "UI2 Signal Type", Step 116, "UI3 Signal Type" or Step 120, "UI4 Signal Type" or for models with the built-in CO₂ sensor, unless otherwise specified.

128. "CO2 MAXIMUM RANGE"



Default: 2000 PPM
Range: 100 to 5000 PPM
Increment: 50 PPM

Select the maximum range value for carbon dioxide (CO₂).

129. "CO2 SETPNT"



Default: 800 PPM
Range: 100 to 2000 PPM
Increment: 10 PPM

Indicates the maximum limit of the CO₂ concentration beyond which an alarm is activated. The setpoint value is restricted by the maximum range at Step 128, "CO2 Maximum Range".



130. "CO2 AUTO SELF CALIB"

 Default: No (Disable)
Range: No (Disable), YES (Enable)

This option appears only for models with the built-in CO₂ sensor. Select whether to enable or disable the automatic self calibration of the CO₂ sensor.

131. "DISPLAY CO2"

 Default: No (Disable)
Range: No (Disable), YES (Enable)

Select whether to enable or disable the display of the CO₂ value.

132. "CO2 CONTROL SOURCE"

 Default: itS (Internal)
Range: itS (Internal), EtS (External)

This option appears only for models with the built-in CO₂ sensor, while also having selected CO₂ at Step 108, "UI1 Signal Type", Step 112, "UI2 Signal Type", Step 116, "UI3 Signal Type" or Step 120, "UI4 Signal Type". Select the source for CO₂ control.

- itS. If selected, the controller will be controlled by its internal CO₂ sensor.
- EtS. If selected, the controller will be controlled by an external CO₂ sensor.

VFD Pressure Settings

The VFD Pressure Settings appear only if you have selected VFdP at Step 17 "AO1 Ramp", or Step 23 "AO2 Ramp", and P10V at Step 108, "UI1 Signal Type", Step 112, "UI2 Signal Type", Step 116, "UI3 Signal Type" or Step 120, "UI4 Signal Type".

133. "PRESSUR MAXIMUM RANGE"

 Default: 2000 Pa
Range: 200 to 200.0 Pa
Increment: 50 Pa

This option appears if you have selected P10V at at Step 108, "UI1 Signal Type", Step 112, "UI2 Signal Type", Step 116, "UI3 Signal Type" or Step 120, "UI4 Signal Type". Select the maximum range for pressure. If the value is higher than 10,000, the value will be divided by 100 and shows a decimal point. For example, 10,000 will be displayed as 100.0 and 10050 will be displayed as 100.5.

134. "VFD PRESSUR SETPNT"

 Default: 500 Pa
Range: 100 to pressure maximum range (value set at Step 133)
Increment: 1 Pa

Select the setpoint value for VFD pressure. If the value is higher than 10,000, the value will be divided by 100 and shows a decimal point. The increment is displayed as 0.1. The fan  symbol is also displayed.

135. "VFD PRESSUR DEAD BAND"

 Default: 50 Pa
Range: 0 to 100 Pa
Increment: 1 Pa

Select the desired dead band value for VFD pressure. The fan  symbol is also displayed.

136. "VFD PRESSUR PROP BAND"

 Default: 200 Pa
Range: 100 to 500 Pa
Increment: 1 Pa

Select the desired proportional band value for VFD pressure. The fan  symbol is also displayed.

137. "VFD PRESSUR INTGRAL SECONDS"

 Default: 0 seconds
Range: 0 to 250 seconds
Increment: 5 seconds

Set the desired value for VFD pressure integral seconds. The fan  symbol is also displayed.



VFD Temperature Settings

The VFD Temperature Settings appear only if you have selected VFdt at Step 17 "AO1 Ramp", or Step 23 "AO2 Ramp".

138. "VFD TEMP SETPNT SOURCE"



Default: VFd (VFD Temp Setpoint)
Range: VFd (VFD Temp Setpoint), CtrlL (User Temp Setpoint)

Select the desired setpoint source for the VFD temperature control. The fan symbol is also displayed.

139. "VFD TEMP SETPNT"



Default: 22.0°C [72°F]
Range: 10.0°C to 40.0°C [50°F to 104°F]
Increment: 0.5°C [1°F]

Select the desired VFD temperature setpoint. The fan symbol is also displayed.

140. "VFD TEMP DEAD BAND"



Default: 0.3°C [0.6°F]
Range: 0.0°C to 5.0°C [0°F to 9°F]
Increment: 0.1°C [0.2°F]

Select the desired VFD temperature dead band value. The fan symbol is also displayed.

141. "VFD TEMP PROP BAND"



Default: 2.0°C [3.6°F]
Range: 0.5°C to 5.0°C [1°F to 9°F]
Increment: 0.1°C [0.2°F]

Select the desired VFD temperature proportional band value. The fan symbol is also displayed.

142. "VFD TEMP INTEGRAL SECONDS"



Default: 0 seconds
Range: 0 to 250 seconds
Increment: 5 seconds

Set the desired value for VFD temperature integral seconds. The fan symbol is also displayed.

143. "VFD TEMP CONTROL SOURCE"



Default: itS (internal)
Range: itS (internal), EtS (External)

Select the source for VFD temperature control.

- *itS.* If selected, the controller will be controlled by its internal temperature sensor.
- *EtS.* If selected, the controller will be controlled by an external temperature sensor.

Temperature Control Source Settings

144. "TEMP CONTROL SOURCE"



Default: itS (internal)
Range: itS (internal), EtS (External), nEt (Network)

Select the source for temperature control.

- *itS.* If selected, the controller will be controlled by its internal temperature sensor.
- *EtS.* If selected, the controller will be controlled by an external temperature sensor.
- *nEt.* If selected, the controller will be controlled by the temperature sent via the BMS.

If you select **itS** or **EtS**, Step 145, "Network Timeout Minutes" will not be available.

If you select **nEt**, Step 145, "Network Timeout Minutes" will be available.

145. "NETWORK TIMEOUT MINUTES"



Default: 5 minutes
Range: 0 to 60 minutes
Increment: 1 minute

This option appears only if you have selected **nEt** at Step 144, "Temp Control Source". Select the duration in minutes after which the controller will go to OFF mode if it does not receive the temperature value via BMS.



Window and Door Settings

146. "WINDOW OPEN MODE"



Default: StP (Setpoint/override enabled)
Range: StP (Setpoint/override enabled), OFF

This option appears only if you have selected **win** at Step 108, "UI1 Signal Type", Step 112, "UI2 Signal Type", Step 116, "UI3 Signal Type" or Step 120, "UI4 Signal Type". The alarm symbol is also displayed.

- *StP. If selected, the controller uses the NSB/No Occupancy setpoints when the window is open.*
- *OFF. If selected, the controller is forced into OFF mode when the window is open.*

147. "WINDOW FAN MODE"



Default: AUto (Automatic)
Range: AUto (Automatic), LO (Low), mEd (Medium), HI (High)

This option appears only if you have selected **win** at Step 108, "UI1 Signal Type", Step 112, "UI2 Signal Type", Step 116, "UI3 Signal Type" or Step 120, "UI4 Signal Type". Select the fan speed mode when the window is open. The fan and alarm symbols are also displayed.

148. "DOOR OPEN MODE"



Default: StP (Setpoint/override enabled)
Range: StP (Setpoint/override enabled), OFF

This option appears only if you have selected **door** at Step 108, "UI1 Signal Type", Step 112, "UI2 Signal Type", Step 116, "UI3 Signal Type" or Step 120, "UI4 Signal Type".

- *StP. If selected, the controller uses the NSB/No Occupancy setpoints when the door is open.*
- *OFF. If selected, the controller is forced into OFF mode when the door is open.*

149. "DOOR FAN MODE"



Default: AUto (Automatic)
Range: AUto (Automatic), LO (Low), mEd (Medium), HI (High)

This option appears only if you have selected **door** at Step 108, "UI1 Signal Type", Step 112, "UI2 Signal Type", Step 116, "UI3 Signal Type" or Step 120, "UI4 Signal Type". Select the fan speed when the door is open. The fan and alarm symbols are also displayed.

Night Set Back (NSB)

150. "NSB OVERRIDE DELAY MINUTES"



Default: 120 minutes
Range: 0 to 180 minutes
Increment: 15 minutes

This option appears only if you have selected **nSb** at Step 108, "UI1 Signal Type", Step 112, "UI2 Signal Type", Step 116, "UI3 Signal Type" or Step 120, "UI4 Signal Type". When in Night Set Back (NSB) Mode, the user can override Night Set Back (NSB) (see page 39) for the duration of this delay. To disable night set back override, set the delay to 0. The moon symbol is displayed to indicate Night Set Back (NSB) Mode.

151. "NSB FAN MODE"



Default: AUto (Automatic)
Range: AUto (Automatic), LO (Low), mEd (Medium), HI (High)

This option appears only if you have selected **nSb** at Step 108, "UI1 Signal Type", Step 112, "UI2 Signal Type", Step 116, "UI3 Signal Type" or Step 120, "UI4 Signal Type". Select the fan speed mode for night set back. The fan symbol is also displayed.

152. "NSB MODE"



Default: StP (Setpoint/override enabled)
Range: StP (Setpoint/override enabled), OFF

This option appears only if you have selected **nSb** at Step 108, "UI1 Signal Type", Step 112, "UI2 Signal Type", Step 116, "UI3 Signal Type" or Step 120, "UI4 Signal Type".

- *StP. If selected, the controller uses the NSB setpoints when in Night Set Back (NSB) Mode. (see page 39).*
- *OFF. If selected, the controller is forced into OFF mode when in Night Set Back (NSB) Mode. (see page 39).*



153. "NSB HEATING SETPNT"

	Default:	16°C	[61°F]
	Range:	10°C to 40°C	[50°F to 104°F]
	Increment:	0.5°C	[1°F]

This option appears only if you have selected **nSb** at Step 108, "UI1 Signal Type", Step 112, "UI2 Signal Type", Step 116, "UI3 Signal Type" or Step 120, "UI4 Signal Type". Set the heating setpoint that will be used when the system is in Night Set Back (NSB) Mode (see page 39). The heating setpoint value is restricted by the cooling setpoint value at Step 154, "NSB Cooling Setpnt". The moon ☾ and heating 🔥 symbols are also displayed.

154. "NSB COOLING SETPNT"

	Default:	28°C	[82°F]
	Range:	10°C to 40°C	[50°F to 104°F]
	Increment:	0.5°C	[1°F]

This option appears only if you have selected **nSb** at Step 108, "UI1 Signal Type", Step 112, "UI2 Signal Type", Step 116, "UI3 Signal Type" or Step 120, "UI4 Signal Type". Set the cooling setpoint that will be used when the system is in Night Set Back (NSB) Mode (see page 39). The cooling setpoint value is restricted by the heating setpoint value at Step 153, "NSB Heating Setpnt". The moon ☾ and cooling ❄ symbols are also displayed.

Occupancy (OCC)

155. "OCC MINIMUM TIME IN MINUTES"

	Default:	30 minutes
	Range:	0 to 720 minutes
	Increment:	1 minute

This option appears only if you have selected **OCC** at Step 108, "UI1 Signal Type", Step 112, "UI2 Signal Type", Step 116, "UI3 Signal Type" or Step 120, "UI4 Signal Type". Set the minimum time in minutes the controller must remain in the occupied state before it can be enabled to enter or re-enter the No Occupancy Mode (see page 39). The moon ☾ symbol is also displayed.

156. "NO OCC OVERRIDE DELAY MINUTES"

	Default:	120 minutes
	Range:	0 to 180 minutes
	Increment:	15 minutes

This option appears only if you have selected **OCC** at Step 108, "UI1 Signal Type", Step 112, "UI2 Signal Type", Step 116, "UI3 Signal Type" or Step 120, "UI4 Signal Type". When in no occupancy mode, the user can override the No Occupancy Mode (see page 39) up to the duration of this delay by pressing the 🌀 button. To disable the no occupancy override, set the delay to 0. The moon ☾ symbol is displayed to indicate the No Occupancy Mode .

157. "NO OCC FAN MODE"

	Default:	AUto (Automatic)
	Range:	AUto (Automatic), LO (Low), mEd (Medium), HI (High)

This option appears only if you have selected **OCC** at Step 108, "UI1 Signal Type", Step 112, "UI2 Signal Type", Step 116, "UI3 Signal Type" or Step 120, "UI4 Signal Type". Select the fan speed mode for no occupancy mode. The fan 🌀 symbol is also displayed.

158. "NO OCC MODE"

	Default:	StP (Setpoint/override enabled)
	Range:	StP (Setpoint/override enabled), OFF

This option appears only if you have selected **OCC** at Step 108, "UI1 Signal Type", Step 112, "UI2 Signal Type", Step 116, "UI3 Signal Type" or Step 120, "UI4 Signal Type". The moon symbol ☾ is also displayed.

- **StP:** If selected, the controller uses the No OCC setpoints when in No Occupancy Mode (see page 39).
- **OFF:** If selected, the controller is forced into OFF mode when in No Occupancy Mode (see page 39).

If you select **OFF**, Steps 159 and 160 will not be available.

159. "NO OCC HEATING SETPNT"

	Default:	16°C	[61°F]
	Range:	10°C to 40°C	[50°F to 104°F]
	Increment:	0.5°C	[1°F]

This option appears only if you have selected **OCC** at Step 108, "UI1 Signal Type", Step 112, "UI2 Signal Type", Step 116, "UI3 Signal Type" or Step 120, "UI4 Signal Type". Set the heating setpoint that will be used when the system is in Night Set Back (NSB) Mode/No Occupancy Mode/Window Open Mode/Door Open Mode. The heating setpoint value is restricted by the cooling setpoint value at Step 160, "No OCC Cooling Setpnt". The moon ☾ and heating 🔥 symbols are also displayed.



160. "NO OCC COOLING SETPNT"



Default: 28°C [82°F]
Range: 10°C to 40°C [50°F to 104°F]
Increment: 0.5°C [1°F]

This option appears only if you have selected **OCC** at Step 108, "UI1 Signal Type", Step 112, "UI2 Signal Type", Step 116, "U13 Signal Type" or Step 120, "UI4 Signal Type". Set the cooling setpoint that will be used when the system is in Night Set Back (NSB) Mode/No Occupancy Mode/Window Open Mode/Door Open mode. The cooling setpoint value is restricted by the heating setpoint value at Step 159, "No OCC Heating Setpnt". The moon ☾ and cooling ❄ symbols are also displayed.

Humidity Settings

The Humidity Settings appear only for the following conditions: if you have selected **HU** at Step 108, "UI1 Signal Type", Step 112, "UI2 Signal Type", Step 116, "U13 Signal Type" or Step 120, "UI4 Signal Type" or for models with the built-in humidity sensor, unless otherwise specified.

161. "EXTERN HUMIDITY SENSOR OFFSET"



Offset: ± 5%
Range: 10% RH to 90% RH
Increment: 0.1% RH

This option appears only if you have selected **HU** at Step 108, "UI1 Signal Type", Step 112, "UI2 Signal Type", Step 116, "U13 Signal Type" or Step 120, "UI4 Signal Type". The display shows the relative humidity percentage read by the external humidity sensor. Adjust the offset by comparing it with a known value humidistat. If the sensor is not connected or short circuited, unit displays the sensor's limits. The humidity 🌡 symbol is also displayed.

162. "INTERN HUMIDITY SENSOR OFFSET"



Offset: ± 5%
Range: 10% RH to 90% RH
Increment: 0.1% RH

This option appears only for models with the built-in humidity sensor. Compare the displayed humidity percentage reading with a known value from a humidistat. This is useful for humidistats installed in areas where the humidity reading is slightly different than the room's actual humidity. For example, a humidistat placed right under the air diffuser. The humidity 🌡 symbol is also displayed.

163. "HUMIDITY CONTROL MODE"



Default: OFF
Range: OFF, Auto (Automatic humidify and dehumidify), dEHU (dehumidify only), Hu (humidify only)

- OFF (Disabled). If selected, the controller disables all humidify and dehumidify functions.
- AuTo (Automatic humidify and dehumidify). If selected, the ramp of at least one analog or binary output must be set to Hu (humidify) and another output must be set to COOL (cooling).
- dEHU (Dehumidify only). If selected, the ramp of at least one analog or binary output must be set to COOL (cooling).
- Hu (Humidify only). If selected, the ramp of at least one analog or binary output must be set to Hu (humidify).

If you select **OFF**, Steps 166 to 175 will not be available.

If you select **Hu** or **deHU**, Step 166 "Humidity User Setpnt Minimum" will be available.

164. "DISPLAY HUMIDITY"



Default: No
Range: No, Yes

This option appears only if you have selected **OFF** at Step 163, "Humidity Control Mode". Select whether to display humidity value or not. If set to No, the controller will not show the humidity value and if set to Yes, it will display the humidity value.

165. "HUMIDITY CONTROL SOURCE"



Default: irh
Range: Erh, irh

This option appears only for models with the built-in humidity sensor, while also having selected **HU** at Step 108, "UI1 Signal Type", Step 112, "UI2 Signal Type", Step 116, "U13 Signal Type" or Step 120, "UI4 Signal Type". Select the source for humidity control.

- irh. If selected, the controller will be controlled by its internal humidity sensor.
- Erh. If selected, the controller will be controlled by an external humidity sensor.



166. "HUMIDITY USER SETPNT MINIMUM"



Default: 30% RH
Range: 10% RH to 90% RH
Increment: 0.5% RH

This option appears only if you have selected **AuTo**, **Hu** or **deHU** at Step 163, "Humidity Control Mode". In Operation Mode, you cannot decrease the setpoint to less than the value set as the minimum humidity setpoint. The minimum value is restricted by the maximum value set at Step 167, "Humidity User Setpnt Maximum". In other words, the value that is set as the minimum cannot be greater than the maximum value.

167. "HUMIDITY USER SETPNT MAXIMUM"



Default: 65% RH
Range: 10% RH to 90% RH
Increment: 0.5% RH

This option appears only if you have selected **AuTo**, **Hu** or **deHU** at Step 163, "Humidity Control Mode". In Operation mode, you cannot increase the setpoint to more than the value set as the maximum humidity setpoint. The maximum value is restricted by the minimum value set at Step 166, "Humidity User Setpnt Minimum". In other words, the value that is set as the maximum cannot be less than the minimum value.

168. "HUMIDITY USER SETPNT LOCKED"



Default: No (Unlocked)
Range: No (Unlocked), Yes (Locked)

This option appears only if you have selected **AuTo**, **Hu** or **deHU** at Step 163, "Humidity Control Mode". If set to **No**, the user setpoint option is not locked and the user can adjust the desired humidity setpoint. If set to **Yes**, the user setpoint option is locked and the user cannot set the desired humidity setpoint. A lock symbol appears to indicate that the setpoint is locked.

169. "HUMIDITY USER SETPNT"



Default: 40% RH
Range: 10% RH to 90% RH
Increment: 0.5% RH

This option appears only if you have selected **AuTo**, **Hu** or **deHU** at Step 163, "Humidity Control Mode". Set the desired humidity setpoint. If the setpoint option was locked at Step 168, "Humidity User Setpnt Locked", a lock symbol is displayed. The setpoint value is restricted by the minimum at Step 166, "Humidity User Setpnt Minimum" and maximum at Step 167, "Humidity User Setpnt Maximum" values.

170. "NSB HUMIDIF SETPNT"



Default: 30% RH
Range: 10% RH to 65% RH
Increment: 0.5% RH

This option appears only if you have selected **AuTo**, **Hu** or **deHU** at Step 163, "Humidity Control Mode", and also **nSb** at Step 108, "UI1 Signal Type", Step 112, "UI2 Signal Type", Step 116, "U13 Signal Type" or Step 120, "UI4 Signal Type". Adjust the humidify setpoint during Night Set Back (NSB) Mode. The humidify setpoint is restricted by the dehumidify value at Step 171, "NSB Dehumi- Setpnt". The moon and humidify symbols are also displayed.

171. "NSB DEHUMI- SETPNT"



Default: 45% RH
Range: 10% RH to 65% RH
Increment: 0.5% RH

This option appears only if you have selected **AuTo**, **Hu** or **deHU** at Step 163, "Humidity Control Mode", and also **nSb** at Step 108, "UI1 Signal Type", Step 112, "UI2 Signal Type", Step 116, "U13 Signal Type" or Step 120, "UI4 Signal Type". Adjust the dehumidify setpoint during Night Set Back (NSB) Mode. The dehumidify setpoint is restricted by the humidify setpoint at Step 170, "NSB Humidif Setpnt". The moon and dehumidify symbols are also displayed.

172. "NO OCC HUMIDIF SETPNT"



Default: 30% RH
Range: 10% RH to 65% RH
Increment: 0.5% RH

This option appears only if you have selected **AuTo**, **Hu** or **deHU** at Step 163, "Humidity Control Mode", and also **OCC** at Step 108, "UI1 Signal Type", Step 112, "UI2 Signal Type", Step 116, "U13 Signal Type" or Step 120, "UI4 Signal Type". Adjust the humidify setpoint during No Occupancy Mode. The humidify setpoint is restricted by the dehumidify value at Step 173, "No OCC Dehumi - Setpnt". The moon and humidify symbols are also displayed.



173. "NO OCC DEHUMI - SETPNT"



Default: 45% RH
Range: 10% RH to 65% RH
Increment: 0.5% RH

This option appears only if you have selected **AuTo**, **Hu** or **deHU** at Step 163, "Humidity Control Mode", and also **OCC** at Step 108, "UI1 Signal Type", Step 112, "UI2 Signal Type", Step 116, "U13 Signal Type" or Step 120, "UI4 Signal Type". Adjust the dehumidify setpoint during No Occupancy Mode. The dehumidify setpoint is restricted by the humidify setpoint at Step 172, "No OCC Humidif Setpnt". The moon ☾ and dehumidify ☹ symbols are also displayed.

174. "HUMIDTY PROP RAMP"



Default: 5% RH
Range: 3% RH to 10% RH
Increment: 0.5% RH

This option appears only if you have selected **AuTo**, **Hu** or **deHU** at Step 163, "Humidity Control Mode". Set the desired proportional ramp value for the humidity control. This value applies to both humidification and dehumidification.

175. "HUMIDTY DEAD BAND"



Default: 1% RH
Range: 0% RH to 5% RH
Increment: 0.5% RH

This option appears only if you have selected **AuTo**, **Hu** or **deHU** at Step 163, "Humidity Control Mode". Set the desired dead band value for the humidity control. This value applies to both humidification and dehumidification.

Anti Freeze

176. "ENABLE ANTI FREEZE PROTECT"



Default: No (Disabled)
Range: No (Disabled), Yes (Enabled)

If this option is enabled, heating starts automatically when the temperature drops to 4°C [39°F], even if the controller is in Cooling or OFF mode. Once the temperature reaches 5°C [41°F], the heating stops.

Delta Temperature

177. "ENABLE DELTA TEMP MODE"



Default: OFF
Range: On, OFF

Select whether to enable or disable the ΔT control based on the inlet and outlet temperature of the water inside the fan coil unit.

178. "DELTA TEMP SETPNT"



Default: 5°C [41°F]
Range: -12°C to 12°C [10.4°F to 53.6°F]
Increment: 0.01°C [0.018°F]

This option appears only if you have selected **On** at Step 177, "Enable Delta Temp Mode". Set the desired value of the setpoint for the ΔT temperature control mode.

Backlight and Contrast Adjustment

179. "USER BACKLIGHT ADJUST" OR "USER CONTRAST ADJUST"



Default: 50
Range: 0 to 100
Increment: 5

Select the backlight or contrast level in the user mode (controller is in operation). Use the ▲ and ▼ buttons to increase or decrease the backlight or contrast level.

180. "OCC BACKLIGHT ADJUST" OR "OCC CONTRAST ADJUST"



Default: 50
Range: 0 to 100
Increment: 5

Select the backlight or contrast level in the occupied mode (controller is idle and occupancy state is active). Use the ▲ and ▼ buttons to increase or decrease the backlight or contrast level.



181. "NO OCC BACKLIGHT ADJUST" OR "NO OCC CONTRAST ADJUST"



Default: 50
Range: 0 to 100
Increment: 5

Select the backlight or contrast level in the not occupied mode (controller is idle and occupancy state is inactive). Use the ▲ and ▼ buttons to increase or decrease the backlight or contrast level.

Network Settings

182. "SELECT NETWORK PROTO"



Default: bAC (BACnet)
Range: bAC (BACnet), mOd (Modbus)

Select the desired network protocol.

BACnet

183. "BACNET AUTO BAUDS RATE"



Default: Yes (Enabled)
Range: Yes (Enabled), No (Disabled)

Enable or disable Auto Baud Rate Detection. When enabled, the controller automatically configures its baud rate by detecting the network speed upon connection to the network.

184. "BACNET BAUDS RATE"



Default: No default (information display only)
Range: 9.6k, 19.2k, 38.4k, 76.8k

If you enabled Auto Baud Rate Detection at Step 183, "BACnet Auto Bauds Rate" the controller displays the automatically detected baud rate.

185. "MSTP MAC ADDRESS"



Default: 0
Range: 0 to 254
Increment: 1

Select the desired MSTP MAC Address. Each device on the network must have a unique MAC address.

186. "MSTP MAX MASTER"



Default: 127
Range: 1 to 127
Increment: 1

Select the desired MSTP MAX address for the master device.

187. "COPY CONFIG"



Default: No (Disable)
Range: No (Disable), Yes (Enable)

Select **Yes** to copy the configuration of the existing device to other devices of the same type on the network. If you select **No**, go to Step 191, "Adjust Device Instance 0153000".

188. "SELECT BEGIN ADDRESS"



Default: 0
Range: 0 to 254
Increment: 1

Select the first address you want to copy to. For example, if you select MAC address 1 as the "begin address" and 54 as the "end address", all the devices from 1 to 54 will receive the configuration of the current device.

189. "SELECT END ADDRESS"



Default: "begin address"
Range: "begin address" + 63
Increment: 1

Select the last address you want to copy to. You cannot copy more than 64 addresses at once.



190. "COPY CONFIG"



Range: "Copy Config" followed by one of these results:
"Succeed", "Progerr", "Typeerr", "Modlerr", "Memerr", "Slave", "Commerr"

Displays "Succeed" if the addresses have been copied successfully. Otherwise, an error message appears with the associated MAC address. You can scroll through the addresses and see the error message associated with each address. See below for a complete list of error messages.

"copy config succeed"

Copy config was successful.

"copy config progerr"

Copy config failed because the target device is in Program Mode.

"copy config typeerr"

Copy config failed because the target device is not the same as the source device. For example, copying an EVC configuration to an EFC device.

"copy config modlerr"

Copy config failed because the model number of the source device and the target device is not the same. For example, copying a TUUB configuration to an EFCB.

"copy config mem err"

Copy config failed because the software/application version of the source device and the target device is not the same.

"copy config Slave"

The target device has a slave address and it cannot respond to the master. Manually verify that the configuration was copied correctly or avoid using a slave address (128 - 254).

"copy config commerr"

Copy config failed because the target device did not respond after 3 attempts. Either the address does not exist or there is a problem with the wiring or with noise.

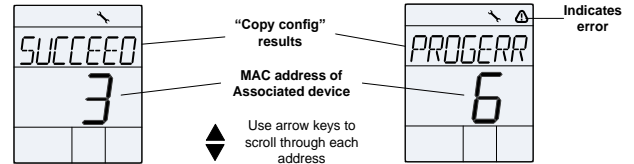

191. "ADJUST DEVICE INSTANCE 0153000"



Default: No
Range: No, rrrrr

To change the device instance, select **Yes** and continue to the next step. If you select **No**, the device instance will be modified automatically according to the MAC address (the menu starts over at Step 1, "Intern Temp Sensor Offset").

192. "0153000"



Default: "current value"
Range: 0 to 4194302
Increment: 1

Use the arrow keys to change the value and press the button to move to the next digit or press to move to the previous digit. Ensure that you provide a unique device instance.

Modbus

193. "MODBUS AUTO BAUDS RATE"



Default: Yes (Automatic)
Range: No (Manual), Yes (Automatic)

Enable or disable Modbus Auto Baud Rate Detection. When enabled, the controller automatically configures its baud rate by detecting the network speed upon connection to the network.

194. "MODBUS BAUDS RATE"



Default: No default (information display only)
Range: 9.6k, 19.2k, 38.4k, 57.6k

If you enabled Modbus Auto Baud Rate Detection at Step 193, "Modbus Auto Bauds Rate", the controller displays the automatically detected baud rate.

195. "MODBUS COMPORT CONFIG"



Default: NP2s (no parity, 2 stop bits)
Range: EP1s (even parity, 1 stop bit), OP1s (odd parity, 1 stop bit), NP2s (no parity, 2 stop bits)

Select the desired parity and number of stop bits for the modbus communication.



196. "MODBUS ADDRESS"



Default: 1
Range: 1 to 247
Increment: 1

Select the desired Modbus address. Each device on the network must have a unique Modbus address.

Scheduling Mode Settings

This menu is accessible through normal operation mode. The Mode Selector Jumper (JP1) must be set to the RUN position (Operation Mode).

1. Press and hold the button for 5 seconds. The "ENTER PASSWORD" screen appears.
2. Enter the password (367) within 1 minute. Use the ▲ and ▼ arrow keys to increase or decrease the value and the , , buttons to toggle between the digits. If you enter the wrong password, the controller displays "Error" and returns to Operation Mode.

Use the same menu operations as described in Programming Mode on page 4.

The controller will return to normal mode if you navigate through the entire menu and do not make any selection, or if you do not press any key for 5 minutes. The changed values will be saved automatically.

= scroll menu items

SCHEDUL MAIN MENU
HrS (Time)
dAtE (Date)
Opt (Options)
SCHd (Schedule)
rSt (Reset Schedule)
quit (Exit Menu)

Time

1. "SET TIME DISPLAY FORMAT"



Default: 12
Range: 12 hours, 24 hours

Select the desired time format.

2. "SET HOURS"



Range: 00 to 23 hours
Increment: 1 hour

Select the time in hours.

3. "SET MINUTES"



Range: 0 to 59 minutes
Increment: 1 minute

Select the time in minutes.

Date

4. "ENTER YEAR"



Default: 2020
Range: 2009 to 2099
Increment: 1 year

Select the year.

5. "ENTER MONTH"



Range: 01 to 12
Increment: 1 month

Select the month.



6. "SET DAY"



Range: 01 to 31 days
Increment: 1 day

Select the day.

Options

7. "USED TIME SCHEDUL"



Default: No
Range: Yes, No

Select whether to schedule events or not. If set to No, then you will proceed to the quit option. If set to Yes, then you will proceed to Step 8, "Schedul Default Value".

8. "SCHEDUL DEFAULT VALUE"



Default: OCC
Range: OFF, OCC (Occupancy), nOCC (Non-Occupancy), LOC (Locally)

Select the default occupancy mode for the schedule.

Schedule

9. "SELECT DAY OF WEEK"



Default: mo
Range: mo (Monday), tu (Tuesday), wE (Wednesday), th (Thursday), Fr (Friday), SA (Saturday), Su (Sunday)

Select the day of the week.

10. "E100:00"



Range: E1 to E6,
00 to 23 hours,
00,15, 30, 45 minutes,
OFF, OCC (Occupancy), nOCC (Non-Occupancy), --- (Null), LOC (Locally)
Increment: 1

Set the parameters to schedule an event. Select the event number, followed by the time (hours and minutes) and occupancy mode. If --- (Null) is selected, then the controller will remain turned off and the event will be unused. To exit the Event menu, press the * button.

Reset Schedule

11. "RESET SCHEDUL"



Default: nO
Range: yES, nO

Select whether to reset and delete the scheduled events or not.

Network Setup Menu

This menu is accessible through normal operation mode. The Mode Selector Jumper (JP1) must be set to the RUN position (Operation Mode).

1. Press the * and # keys for 5 seconds. The "ENTER PASSWORD" screen appears.
2. Enter the password (637) within 1 minute. Use the ▲ and ▼ arrow keys to increase or decrease the value and the * and # buttons to toggle between the digits. If you enter the wrong password, the controller displays "Error" and returns to Operation Mode.

Use the same menu operations as described in Programming Mode on page 4.

The controller will return to normal mode if you navigate through the entire menu and do not make any selection, or if you do not press any key for 5 minutes. The changed values will be saved automatically.

1. "SELECT NETWORK PROTO TO MODBUS ADDRESS"



Range: Steps 182 to 196
Page: Page 33 to 35

These network setup steps are exactly the same as those in the Programming Mode. Please refer to Steps 182 to 196, starting on page 33. When complete, continue to the following step.



Sensor Offset Menu

This menu is accessible through normal operation mode. The Mode Selector Jumper (JP1) must be set to the RUN position (Operation Mode).

1. Press the and keys for 5 seconds. The "ENTER PASSWORD" screen appears.
2. Enter the password (372) within 1 minute. Use the and arrow keys to increase or decrease the value and the , buttons to toggle between the digits. If you enter the wrong password, the controller displays "Error" and returns to Operation Mode.

Use the same menu operations as described in Programming Mode on page 4.

The controller will return to normal mode if you navigate through the entire menu and do not make any selection, or if you do not press any key for 5 minutes. The changed values will be saved automatically.

1. "INTERN TEMP SENSOR OFFSET"

	Range:	0°C to 50°C	[32°F to 122°F]
	Offset:	Max. ± 5°C	[± 9°F]
	Increment:	0.1°C	[0.2°F]

Compare the displayed temperature reading with a known value from a thermometer or other temperature sensing device. To offset or calibrate the sensor, use the arrow buttons to set the desired temperature reading. This is useful for controllers installed in areas where the temperature read is slightly different than the room's actual temperature. For example, a controller placed right under the air diffuser.

2. "EXTERN TEMP SENSOR OFFSET"

	Range:	-40.0°C to 100°C	[-40°F to 212°F]
	Offset:	Max. ± 5°C	[± 9°F]
	Increment:	0.1°C	[0.2°F]

This option appears only if you have selected **t10.0** or **t10V** at Step 108, "UI1 Signal Type" or Step 112, "UI2 Signal Type". The display shows the temperature read by the external temperature sensor. Adjust the offset by comparing it with a known value (e.g. thermometer). If the sensor is not connected or short circuited, the unit displays the sensor's limit.

3. "EXTERN HUMIDITY SENSOR OFFSET"

	Offset:	± 5%
	Range:	10% RH to 90% RH
	Increment:	0.1% RH

This option appears if the controller is set to use an external humidity sensor. The display shows the relative humidity percentage read by the external humidity sensor. Adjust the offset by comparing it with a known value humidistat. If the sensor is not connected or short circuited, unit displays the sensor's limits. The humidify symbol is also displayed.

4. "VFD PRESSUR SETPNT"

	Default:	500 Pa
	Range:	100 to pressure maximum range
	Increment:	1 Pa

This option appears only if you have selected **VFdP** at Step 17, "AO1 Ramp", or Step 23, "AO2 Ramp", and **P10V** at Step 108, "UI1 Signal Type", Step 112, "UI2 Signal Type", Step 116, "UI3 Signal Type" or Step 120, "UI4 Signal Type". Select the setpoint value for VFD pressure. The fan symbol is also displayed.

5. "VFD TEMP SETPNT"

	Default:	22.0°C	[72°F]
	Range:	10.0°C to 40.0°C	[50°F to 104°F]
	Increment:	0.5°C	[1°F]

This option appears only if you have selected **VFdt** at Step 17 "AO1 Ramp", or Step 23, "AO2 Ramp". Select the setpoint value for VFD pressure. The fan symbol is also displayed.

Reset to Factory Default Settings



This will erase all actual configurations and replace them with the factory default settings.

1. The Mode Selector jumper (JP1) of the digital room sensor must be set to the "RUN" position (Operation Mode). Refer to Wiring section on page 3.
2. During the power up sequence of the controller and digital room sensor, press and hold both the [] and buttons.
3. The "ENTER PASSWORD" screen appears. Enter 372 within 1 minute by using the arrow keys to increase or decrease the value and the [] and [] buttons to toggle between the digits.
4. Use the arrow buttons to select YES and then press []



Operation Mode

The Mode Selector Jumper JP1 must be set to the RUN position (Operation Mode). Refer to the Wiring section on page 3.

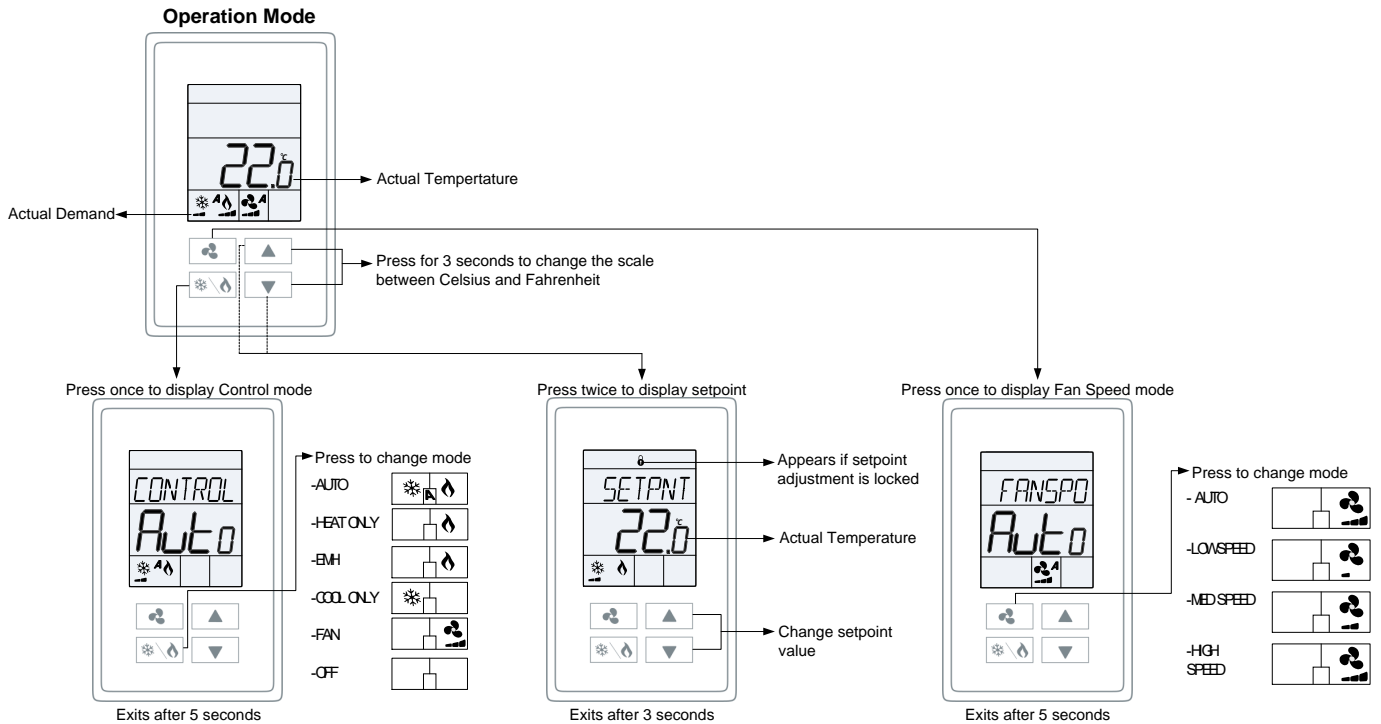

Power Up

Upon power up, the LCD illuminates and all segments appear for 2 seconds. The controller then displays its current version for 2 seconds.

LCD Backlight

Pressing any key illuminates the LCD for 4 seconds.

Default Display

The controller displays temperature and humidity readings or setpoints, with or without demand according to the selection made at Step 8, "Display Info". If a humidity sensor is not used, the temperature values will always be displayed. If a sensor is disconnected or short circuited, then the unit displays the sensor's limits. To toggle the temperature scale between °C and °F, press both the up ▲ and down ▼ arrow keys for 3 seconds.

Temperature Setpoint Display and Adjustment

To display the setpoint, press the ▲ or ▼ key twice. The setpoint appears for 3 seconds. To adjust the setpoint, press the arrow keys while the setpoint is displayed. If the setpoint adjustment has been locked (Step 5, "User Setpnt"), the lock symbol appears.

Humidity Setpoint Display and Adjustment

To access the Humidity setpoint, press the button for 5 seconds. The humidity setpoint will be displayed for 5 seconds. To adjust the setpoint, press the ▲ and ▼ keys while the setpoint is displayed. The unit automatically exits this menu if you do not press any key for 3 seconds. The changed values will be saved automatically.

Control Mode



To access the Control Mode, press the key. The Control Mode appears for 5 seconds. Press the key to scroll through the following control modes. These options can vary depending on the options selected at the following:

- Step 6, "Temp Control Mode"
- Step 7, "Enable On Off Control Mode"
- Step 12, "Heat Pump Option"
- Step 43, "Fan Speed Option"

- Auto (Automatic Cooling or Heating)
- Cooling only (on, with cooling * symbol)
- Heating only (on, with heating symbol)
- EmH (on, with heating symbol)
- FAN (on, with fan symbol)
- OFF (if it is not disabled in Programming Mode)





Fan Speed Selection Mode

To access the Fan Speed selection mode, press the  key. The mode appears for 5 seconds. These options can vary depending on the fan speed signal and auto mode settings at Step 46, "Fan Auto Mode" and Step 42, "Fan Spd Signal". If in No Occupancy mode, the  button now serves as the override button.

The Fan Speed Selection Mode is not available when VFD analog output is used and if **Yes** is selected at Step 45, "Hide Fan Display Info".





- Automatic speed. This option is available if you have selected **yES** (Enable) at Step 46, "Fan Auto Mode" in Programming Mode.
- Low speed
- Medium speed
- High speed
- OFF. OFF is not selectable by the user, it appears only if the "Control Mode" is "OFF" and it indicates that the user cannot change the speed of the fan.

Night Set Back (NSB) Mode





This function is only available if you have set input to **nSb** (Night Set Back contact). If the contact is triggered, the controller enters NSB Mode (the  symbol appears) and uses the NSB setpoints defined at Steps 153, "NSB Heating Setpnt", 154, "NSB Cooling Setpnt" and 151, "NSB Fan Mode". Press any key to override NSB for the delay defined at Step 150, "NSB Override Delay Minutes". The  symbol flashes to indicate that the NSB mode is overridden (during this time the standard setpoints are used).

No Occupancy Mode

This function is only available if you have set input to **OCC** (occupancy contact). If the contact is triggered and the minimum occupancy time defined at Step 155, "OCC Minimum Time In Minutes" has elapsed, the controller enters No Occupancy Mode (the  symbol appears) and uses the No OCC setpoints defined at Steps 159, "No OCC Heating Setpnt", 160, "No OCC Cooling Setpnt" and 157, "No OCC Fan Mode".

Press the fan  button to override no occupancy. Each time you press the  button, 15 minutes are added to the override up to a maximum defined by Step 156, "No OCC Override Delay Minutes". Press the fan  button until "0" is displayed to disable the override. The  icon will flash and the remaining override time will be displayed in minutes.

Backlight and Contrast Level Adjustment

For models with the grey LCD screen, the backlight level can be adjusted. For models with the black LCD screen, the contrast level can be adjusted. Press and hold the  and  buttons for 5 seconds and enter the password **367** to gain access to the backlight and contrast level adjustment settings. Use the  and  keys to adjust the backlight or contrast level in three modes: User (controller is in operation), Occupied (controller is idle and occupancy state is active) and Not Occupied (controller is idle and occupancy state is inactive). Press the  key to save any changes.



Recycling at end of life: please return this product to your Neptronic local distributor for recycling. If you need to find the nearest Neptronic authorized distributor, please consult www.neptronic.com.